

SACTO

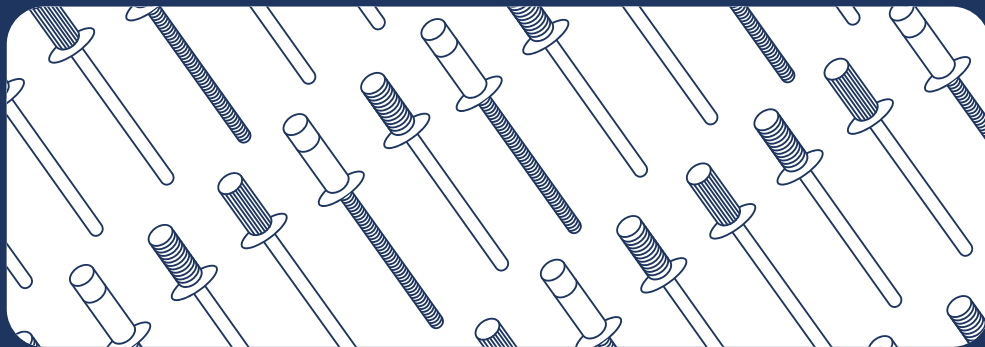

RIVETTI - RIVETS



INSERTI FILETTATI - THREADED INSERTS

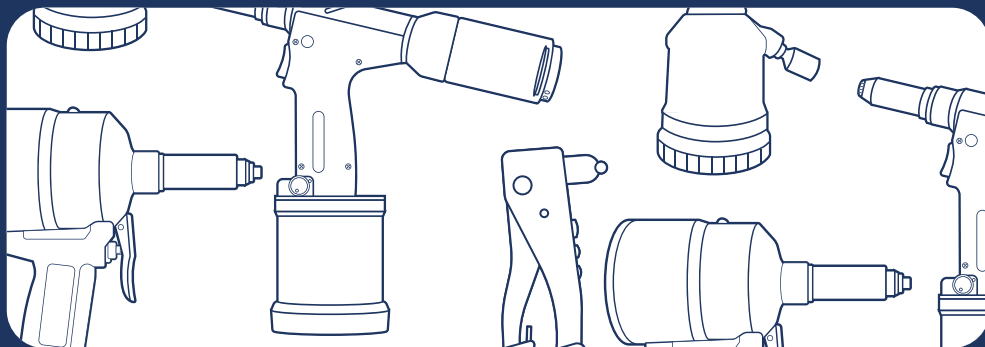

RIVETTATRICI - RIVETING TOOLS

LISTINO PREZZI • PRICE LIST N° 17



Sistemi di fissaggio e prodotti per l'industria

Fondata nel 1974, la SACTO ha avviato la propria attività producendo e commercializzando rivetti a strappo, inserti filettati e rivettatrici per inserti e rivetti.

Con l'esperienza maturata nel corso degli ultimi 50 anni e seguendo lo stimolo costante di migliorare la propria offerta e la propria struttura, la SACTO è oggi una delle aziende di riferimento nel settore dei fasteners: i nostri prodotti sono distribuiti a varie tipologie di clientela sul mercato nazionale ed internazionale.

La professionalità e la tempestività nel rispondere alle esigenze del cliente sono i nostri punti di forza, assieme ad un'offerta di prodotti in costante espansione, che spazia dal rivetto a strappo, all'inserto filettato, rivettatrici per rivetti e inserti manuali e oleopneumatiche, prodotti per l'industria.









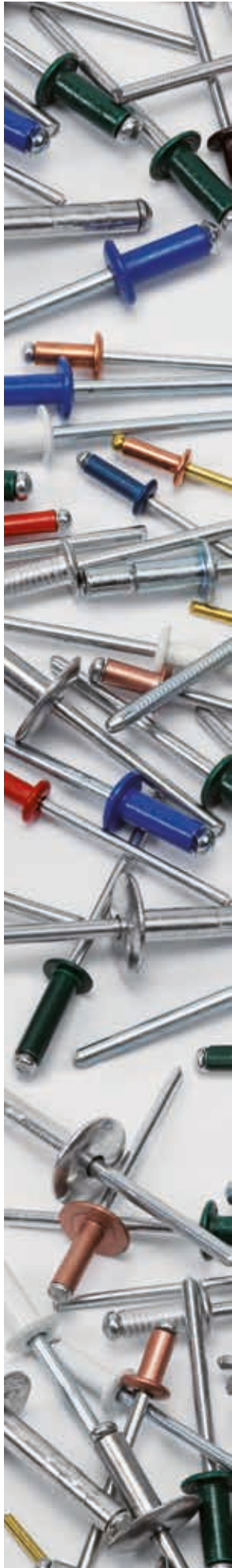





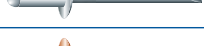







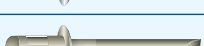

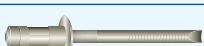
Il nostro obiettivo è la piena soddisfazione delle esigenze della clientela, proponendoci come vero partner dei nostri clienti, per offrire nuove soluzioni e servizi adatti alle più diverse esigenze.

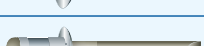

QUANDO LA PERFEZIONE
DIVENTA UN CLASSICO



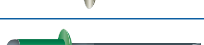

			Pag.
	Alluminio - Acciaio Standard	Aluminium - Steel Standard	7 - 8
	Alluminio - Acciaio Testa Svasata	Aluminium - Steel CH	9
	Alluminio - Acciaio Testa Larga	Aluminium - Steel LH	10
	Alluminio - Inox	Aluminium - Stainless Steel	11
	Alluminio - Alluminio	Aluminium - Aluminium	12
	Acciaio - Acciaio Standard	Steel - Steel Standard	13
	Rame - Acciaio	Copper - Steel	14
	Rame - Ottone	Copper - Brass	15
	Rullati	Grooved	16
	Graf	Peel	17
	Tribloc - Tribol	Tribloc - Tribol	18
	Inox - Inox	Stainless Steel - Stainless Steel	19
	Inox - Testa larga	Stainless Steel - Large head	20
	Unigrip - Alluminio acciaio	Unigrip Rivets	21
	Acciaio - Acciaio	Steel - Steel	22
	Alluminio - Acciaio Testa Svasata	Aluminium - Steel CH	23
	Inox - Inox	Stainless Steel - Stainless Steel	24
	Alluminio - Acciaio Testa Larga	Aluminium - Steel LH	25
	Alluminio - Inox	Aluminium - Stainless Steel	26
	Stagno - Alluminio	Sealed Rivets Alu	27
	Stagno - Rame	Sealed Rivets Copper	28
	Stagno - Inox	Sealed Rivets Stainless Steel	28
	Rivetto massa	Earther rivet	29
	Unibolt	Unibolt	30
	Unibulb	Unibulb	31
	Rivetti verniciati	Painted rivets	32
	Confezione Self-Service	Self-Service packaging	34



INSERTI FILETTATI BLIND NUTS BLINDEINNIETMUTTERN

			Pag.
	Inserti Filettati	Blind Nuts	36
	Acciaio	Steel	36 - 42
	Alluminio	Aluminium	43 - 45
	Inox	Stainless Steel	46 - 48
	Acciaio esagonali	Steel hex.	49 - 56



RIVETTATRICI RIVETING TOOLS HANDNIETZANGE

			Pag.
	Rivettatrici manuali	Hand Blind Riveting Tools	58 - 59
	Rivettatrici oleopneumatiche e rivettatrici a batteria	Hydropneumatic Tools e rivettatrici a batteria	60 - 62
	Tirainseriti manuali Tirainseriti oleopneumatiche	Hand Blind Nuts Riveters Hydropneumatic tools	63 - 66



PRODOTTI SPECIALI SPECIAL PRODUCTS SPEZIELLE PRODUKTE

			Pag.
	Inserti filettati maschi	Male Blind Nuts	70
	Inserti filettati speciali	Special Blind Nuts	71
	Dadi in gabbia	Cage Nuts	72
	Dadi tondi 4 punte	Round Threaded Nuts 4 Tips	73
	Mollette con collarino	Deep threaded u nuts	74
	Piastrine per viti metriche	U nuts for metric screws	75
	Perni autoaggancianti	Clinch Studs	76
	Perni filettati	Threaded Pins	77





INDICAZIONI TECNICHE:

L'utilizzo dei rivetti a strappo o inserti filettati risulta ottimale qualora si tengano in considerazione alcuni parametri tecnici di impiego.

Ogni rivetto o inserto assolve a esigenze particolari a seconda del materiale e della forma con i quali viene realizzato. In tutti i casi però bisogna tenere presente che, essendo l'accoppiamento reso possibile attraverso fori di assemblaggio, questi, per l'ottimizzazione del risultato, devono rispettare parametri precisi. In primo luogo ovviamente il foro deve essere maggiore rispetto al diametro nominale del rivetto o inserto per consentirne l'inserimento, ma la maggiorazione non deve superare il valore di 0,2 mm altrimenti l'accoppiamento potrebbe risultare difettoso.

Un ulteriore parametro da considerare è la lunghezza del rivetto o inserto che è direttamente proporzionale allo spessore complessivo delle lamiere da serrare.

Comunque, per facilitare questa scelta, è stata elaborata una tabella indicativa per ogni tipo di rivetto o inserto, tabella nella quale vengono riportate anche le caratteristiche meccaniche di ogni serraggio. Consigliamo pertanto di attenersi a quanto indicato onde evitare spiacevoli inconvenienti.

TECHNICAL INFORMATION:

During the assembly operation, control if the holes observe the following parameters: the hole must be larger than the diameter of the blind rivets or threaded insert. However, this increase had not to exceed 0,2 mm, otherwise the application could present flaws.

Moreover, remember that the length of the rivets or inserts is proportional to the total thickness of the plates to be fixed.

In our catalogue you will find a table for each type of rivet or insert, which shows all the mechanical characteristics of the products, in order to simplify every possible choice. To avoid problems, please follow the information above stated.

TECHNISCHE INFORMATIONEN:

Während des Montage ist zu kontrollieren, ob die Bohrlöcher folgende Parameter aufweisen: das Bohrlöcher muss größer als der Durchmesser des Nietdorns oder der Ennietmutter sein. Allerdings nicht mehr als 0,2 mm, anderenfalls kommt keine optimale Verbindung zustande.

Es ist ferner wichtig, zu beachten, dass die Nietdorn oder die Ennietmutter länger ist als die Stärke der zu verbindenden Teile.

In unserem Katalog finden Sie eine Tabelle mit allen wichtigen Maßangaben, die für die Auswahl des richtigen Nietes erforderlich sind.

Wenn Sie Probleme bei der Montage ausschalten wollen, beachten Sie bitte die obigen Vorgaben.

MATERIALI

Materiali utilizzati	Materials used	Materialien
Alluminio AlMg 2,5	Aluminium AlMg 2,5	Alu AlMg 2,5
Alluminio AlMg 3,5	Aluminium AlMg 3,5	Alu AlMg 3,5
Alluminio AlMg 5,0	Aluminium AlMg 5,0	Alu AlMg 5,0
Alluminio Al 99,5	Aluminium Al 99,5	Alu Al 99,5
Acciaio zincato	Steel zinc plated	Stahl verzinkt
Acciaio C4C	Steel C4C	Stahl C4C
Acciaio inox Aisi 304 CU	Stainless steel Aisi 304 CU	Edelstahl Aisi 304 CU
Acciaio inox A2	Stainless steel A2	Edelstahl A2
Rame	Copper	Kupfer
Ottone	Brass	Messing



Diametro del foro
Hole diameter
Bohrungsdurchmesser

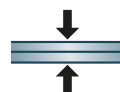

Spessori serrabili minimi e massimi
Grip range
Min. und max. Schliessdicke

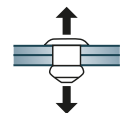

Carico di rottura a trazione in N
Tensile strength N
Zugfestigkeit in N

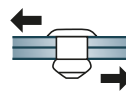

Carico di rottura a taglio in N
Shearing strength N
Scherfestigkeit in N

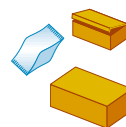

Numero di rivetti contenuti in ogni
sacchetto/cartone
Number of pieces each bag/box
Stückzahl pro Beutel/Karton

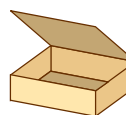

Numero di rivetti contenuti
in ogni scatola
Number of pieces each box
Stückzahl pro Beutel

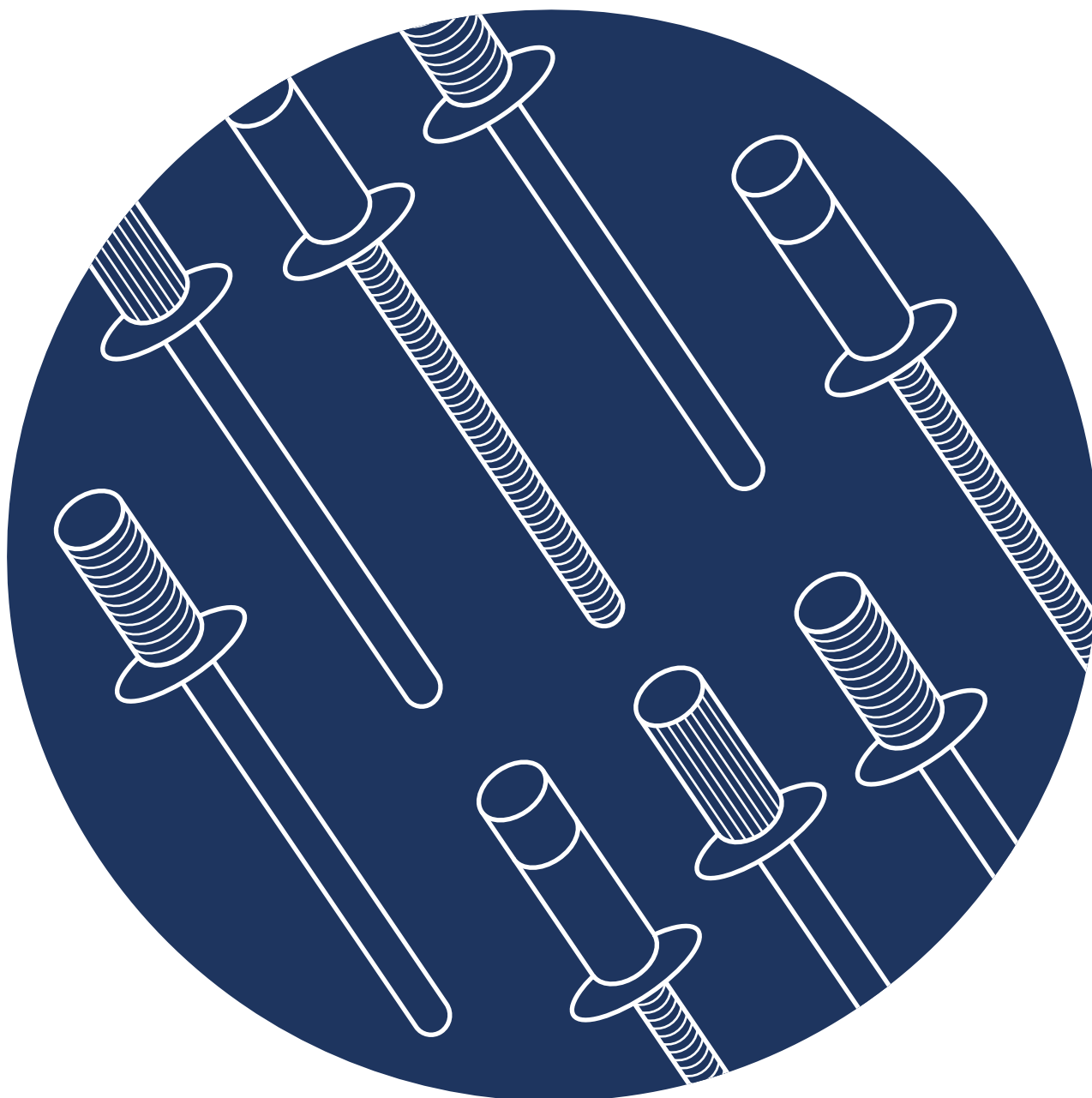

RIVETTI

RIVETS

BLINDNIETE



SCATOLE IMBALLO

BOX

BEUTEL

RIVETTI IN ALLUMINIO CHIEDO ACCIAIO ZINCATO

ALUMINIUM DOME HEAD RIVETS-ZINC PLATED NAIL

ALU BLINDNIETE MIT NIETDORN AUS STAHL

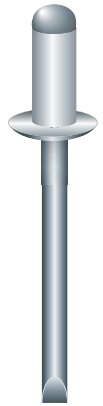

d mm	L mm	D mm							Cod. Art. Item code	€ per 1.000	
2,4	6	5	2,5	0,5÷3	440	350	1.000	12.000	101 2406	19,60	
	8			3÷5			1.000	8.000		20,80	
	10			5÷7			1.000	8.000		22,00	
	12			7÷9			1.000	8.000		24,40	
3	5	6	3,1	1-2	800	660	1.000	12.000	101 3005	15,70	
	6			2÷3			1.000	12.000		15,70	
	8			3÷5			1.000	12.000		17,30	
	10			5÷7			1.000	8.000		18,90	
	12			7÷9			1.000	8.000		19,80	
	14			9÷11			1.000	8.000		20,60	
	16			11÷13			1.000	8.000		23,30	
18	13÷15	1.000	8.000	3018	27,10						
3,2	6	6,5	3,3	0,5÷3	950	680	1.000	8.000	101 3206	16,30	
	8			3÷5			1.000	8.000		17,90	
	10			5÷7			1.000	8.000		19,70	
	12			7÷9			1.000	8.000		21,20	
	14			9÷11			1.000	8.000		23,60	
	16			11÷13			1.000	8.000		3216	25,10
18	13÷15	1.000	8.000	3218	28,20						
3,4	6	7	3,5	0,5÷3	1210	850	1.000	8.000	101 3406	16,70	
	7			3÷4			1.000	8.000		17,20	
	9			4÷6			1.000	8.000		19,10	
	11			6÷8			1.000	8.000		21,10	
	12			8÷9			1.000	8.000		3412	21,60
	14			9÷11			1.000	8.000		3414	22,80
	16			11÷13			1.000	8.000		3416	26,00
	18			13÷15			1.000	8.000		3418	27,60
20	15÷17	1.000	8.000	3420	32,30						
4	5	8	4,1	0,5÷1,5	1850	1300	1.000	8.000	101 4005	17,60	
	6			1,5÷2,5			1.000	8.000		4006	17,60
	8			2,5÷4,5			1.000	8.000		4008	19,10
	9			3,0÷5,0			1.000	8.000		4009	21,10
	10			4,5÷6,5			1.000	8.000		4010	21,20
	12			6,5÷8,5			1.000	8.000		4012	24,00
	14			8,5÷10,5			1.000	8.000		4014	26,10
	16			10,5÷12,5			500	4.000		4016	27,60
	18			12,5÷14,5			500	4.000		4018	29,90
	20			14,5÷16,5			500	4.000		4020	30,90
	25			16,5÷21,5			500	4.000		4025	36,70
	30			21,5÷26,5			500	4.000		4030	49,40

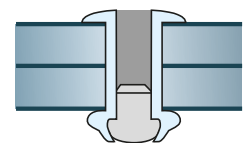
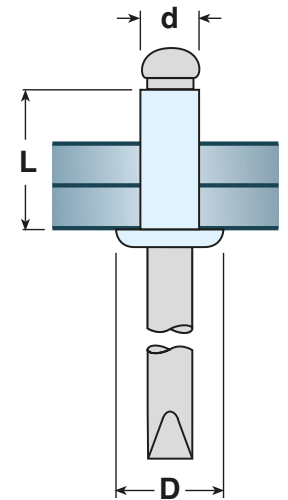

RIVETTI IN ALLUMINIO CHIEDO ACCIAIO ZINCATO
ALUMINIUM DOME HEAD RIVETS-ZINC PLATED NAIL
ALU BLINDNIETE MIT NIETDORN AUS STAHL

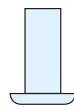
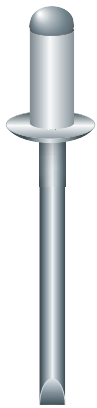





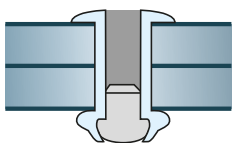
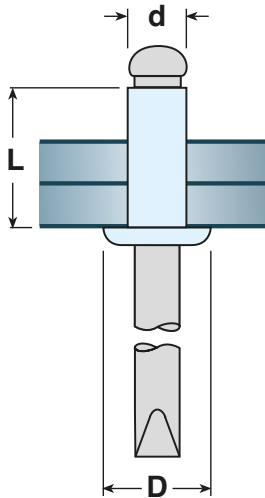

Alluminio
Aluminium
Aluminium



Acciaio zincato
Zinc plated steel
Stahl Verzinkt







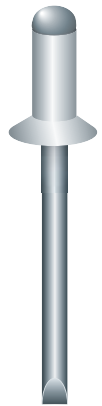

d mm	L mm	D mm	 mm	 mm	 N	 N			Cod. Art. Item code	€ per 1.000			
4,8	6	9,5	5	0,5÷2	2950	2170	1.000	8.000	101 4806	21,00			
	8			2÷4						1.000	8.000	4808	22,60
	10			4÷6						500	4.000	4810	25,70
	12			6÷8						500	4.000	4812	28,20
	14			8÷10						500	4.000	4814	34,20
	16			10÷12						500	4.000	4816	37,30
	18			12÷14						500	4.000	4818	41,10
	20			14÷16						500	4.000	4820	44,70
	25			16÷21						250	2.000	4825	50,30
	30			21÷26						250	2.000	4830	58,70
	35			26÷31						250	2.000	4835	67,80
40	31÷36	250	2.000	4840	80,60								
50	41÷46	250	2.000	4850	110,00								
6	8	12	6,1	2÷3	3700	2500	500	4.000	101 6008	53,80			
	10			3÷5						500	4.000	6010	57,40
	12			5÷7						500	4.000	6012	59,10
	15			7÷10						250	2.000	6015	60,80
	18			10÷13						250	2.000	6018	64,00
	22			13÷17						250	2.000	6022	68,40
	26			17÷21						250	2.000	6026	70,90
	30			21÷25						250	2.000	6030	89,00
	35			25÷30						-	1.000	6035	117,40
	40			30÷35						-	1.000	6040	139,50
6,4	8	13	6,5	2÷3	4950	3200	500	4.000	101 6408	62,00			
	10			3÷5						250	2.000	6410	65,80
	12			5÷7						250	2.000	6412	67,00
	15			7÷10						250	2.000	6415	70,50
	18			10÷13						250	2.000	6418	76,20
	22			13÷17						250	2.000	6422	81,00
	26			17÷21						250	2.000	6426	84,20
	30			21÷25						-	1.000	6430	97,00
	35			25÷30						-	1.000	6435	125,60
	40			30÷35						-	1.000	6440	139,50
7,8	15	14	8	4÷9	8750	5500	250	2.000	101 7815	113,40			
	18			9÷12						250	2.000	7818	117,90
	22			12÷16						-	1.000	7822	132,30
	26			16÷20						-	1.000	7826	146,50

RIVETTI A TESTA SVASATA IN ALLUMINIO

ALUMINIUM COUNTERSUNK HEAD RIVETS

ALU BLINDNIETE SENKKOPF



d mm	L mm	D mm	 mm	 mm	 N	 N			Cod. Art. Item code	€ per 1.000	
3,2	8	6	3,3	2÷4	950	680	1.000	8.000	103 3208	19,00	
	10			4÷6			1.000	8.000		3210	21,00
	12			6÷8			1.000	8.000		3212	23,00
	14			8÷10			1.000	8.000		3214	26,00
4	8	7,5	4,1	2÷4	1850	1300	1.000	8.000	103 4008	20,80	
	10			4÷6			1.000	8.000		4010	22,10
	12			6÷8			1.000	8.000		4012	26,00
	14			8÷10			1.000	8.000		4014	27,80
	16			10÷12			500	4.000		4016	30,40
	18			12÷14			500	4.000		4018	33,00
4,8	8	9	5	2÷3	2950	2170	500	4.000	103 4808	24,50	
	10			3÷5			500	4.000		4810	27,00
	12			5÷7			500	4.000		4812	30,50
	14			7÷9			500	4.000		4814	35,60
	16			9÷11			500	4.000		4816	39,60
	18			11÷13			500	4.000		4818	45,00
	20			13÷15			500	4.000		4820	50,00

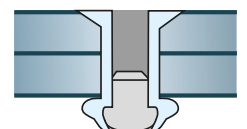
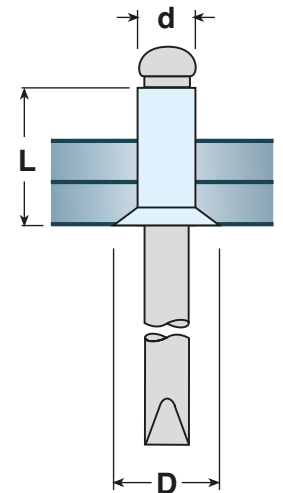

RIVETTI IN ALLUMINIO A TESTA LARGA

LARGE HEAD ALUMINIUM RIVETS

ALU BLINDNIETE GRÖBKOPF

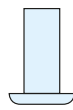

Alluminio
Aluminium
Aluminium



Acciaio zincato
Zinc plated steel
Stahl Verzinkt

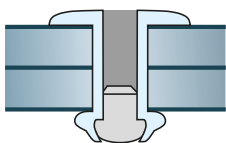
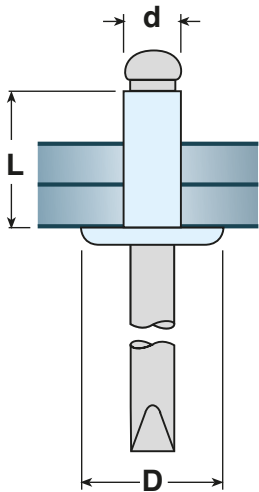

d mm	L mm	D mm							Cod. Art. Item code	€ per 1.000	
3,2	8	9,5	3,3	3÷5	980	680	1.000	8.000	105 3208	18,70	
	10			5÷7			1.000	8.000		3210	20,60
	12			7÷9			1.000	8.000		3212	22,80
	14			9÷11			1.000	8.000		3214	24,50
4	8	10	4,1	3÷4	1850	1300	1.000	8.000	105 4008	22,00	
	10			4÷6			500	4.000		4010	24,40
	12			6÷8			500	4.000		4012	27,60
	14			8÷10			500	4.000		4014	30,00
	16			10÷12			500	4.000		4016	31,60
4	8	12	4,1	3,5÷4,5	1850	1300	500	4.000	107 4008	22,90	
	10			4,5÷6,5			500	4.000		4010	27,20
	12			6,5÷8,5			500	4.000		4012	30,80
	14			8,5÷10,5			500	4.000		4014	32,50
	16			10,5÷12,5			500	4.000		4016	34,40
	18			12,5÷14,5			500	4.000		4018	35,80
	20			14,5÷16,5			500	4.000		4020	37,40
4,8	8	14	5	3÷4	2950	2170	500	4.000	105 4808	26,00	
	10			4÷6			500	4.000		4810	30,80
	12			6÷8			500	4.000		4812	33,80
	14			8÷10			500	4.000		4814	40,00
	16			10÷12			250	2.000		4816	43,00
	18			12÷14			250	2.000		4818	50,00
	20			14÷16			250	2.000		4820	51,50
	26			16÷21			250	2.000		4826	58,80
	30			21÷26			250	2.000		4830	67,60
	35			26÷31			250	2.000		4835	78,00
	40			31÷36			-	1.000		4840	91,00
	45			36÷41			-	1.000		4845	105,00
50	41÷46	-	1.000	4850	126,00						
4,8	10	16	5	4÷6	2950	2170	250	2.000	107 4810	32,20	
	12			6÷8			250	2.000		4812	35,50
	14			8÷10			250	2.000		4814	42,00
	16			10÷12			250	2.000		4816	45,20
	18			12÷14			250	2.000		4818	52,00
	20			14÷16			250	2.000		4820	54,00
	26			16÷21			250	2.000		4826	62,20
	30			21÷26			250	2.000		4830	71,00
35	26÷31	250	2.000	4835	81,60						

RIVETTI IN ALLUMINIO CHiodo INOX

ALUMINIUM RIVETS - STAINLESS NAIL

ALU BLINDNIETE MIT NIETDORN EDELSTAHL



d mm	L mm	D mm							Cod. Art. Item code	€ per 1.000			
			mm	mm	N	N							
3	6	6	3,1	1÷3	880	640	1.000	12.000	109	3006	33,50		
	8			3÷5			1.000	12.000				3008	35,30
	10			5÷7			1.000	8.000					
	12			7÷9			1.000	8.000				3012	37,90
3,2	6	6,5	3,3	1÷3	950	680	1.000	12.000	109	3206	36,10		
	8			3÷5			1.000	8.000				3208	38,70
	10			5÷7			1.000	8.000					
	12			7÷9			1.000	8.000				3212	44,80
4	6	8	4,1	1÷2	1850	1300	1.000	8.000	109	4006	51,30		
	8			2÷4			1.000	8.000				4008	55,00
	10			4÷6			1.000	8.000					
	12			6÷8			1.000	8.000				4012	62,40
	14			8÷10			1.000	8.000					
	16			10÷12			500	4.000				4016	67,90
	18			12÷14			500	4.000					
	20			14÷16			500	4.000				4020	74,50
4,8	8	9,5	5	3÷4	2950	2170	500	4.000	109	4808	78,90		
	10			4÷5			500	4.000				4810	85,30
	12			6÷7			500	4.000					
	14			7÷9			500	4.000				4814	93,20
	16			9÷11			500	4.000					
	18			11÷13			500	4.000				4818	101,80
	20			13÷15			500	4.000					

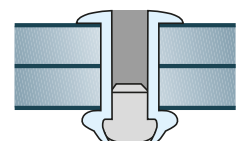
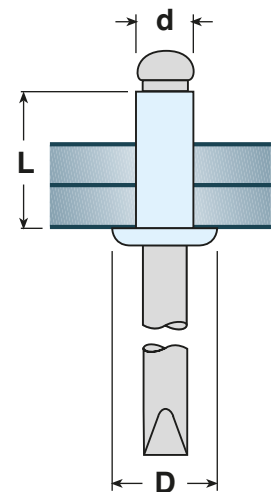

RIVETTI IN ALLUMINIO - CHIEDO ALLUMINIO

ALUMINIUM RIVETS - ALUMINIUM NAIL

ALU BLINDNIETE - ALU NIETDORN

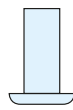

Alluminio
Aluminium
Aluminium



Alluminio
Aluminium
Aluminium

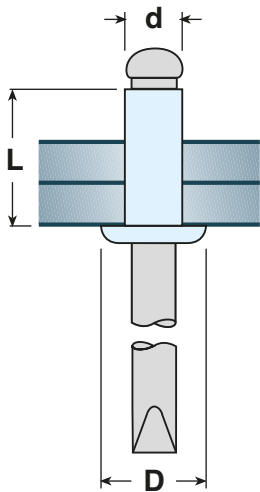

d mm	L mm	D mm							Cod. Art. Item code	€ per 1.000	
3,2	6	6,5	3,3	1÷3	700	400	1.000	8.000	111 3206	15,90	
	8			3÷5			1.000	8.000		3208	16,80
	10			5÷7			1.000	8.000		3210	17,20
	12			7÷9			1.000	8.000		3212	19,30
4	6	8	4,1	1÷2	1200	800	1.000	8.000	111 4006	24,90	
	8			2÷4			1.000	8.000		4008	27,00
	10			4÷6			1.000	8.000		4010	28,80
	12			6÷8			1.000	8.000		4012	33,40
	14			8÷10			1.000	8.000		4014	34,20
	16			10÷12			500	4.000		4016	39,70
	18			12÷14			500	4.000		4018	42,80
4,8	8	9,5	5	2÷4	1500	1050	500	4.000	111 4808	42,00	
	10			4÷6			500	4.000		4810	44,30
	12			6÷8			500	4.000		4812	48,50
	14			8÷10			500	4.000		4814	49,00
	16			10÷12			500	4.000		4816	53,60
	18			12÷14			500	4.000		4818	56,50

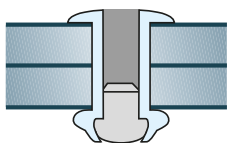

RIVETTI TUTTO ACCIAIO ZINCATO TESTA TONDA





ZINC PLATED STEEL RIVETS

STAHL BLINDNIETE FLACHRUNDKOPF MIT NIETDORN AUS STAHL

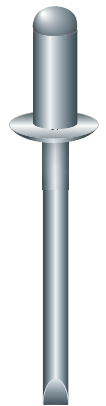
 Acciaio zincato
 Zinc plated steel
 Stahl Verzinkt

 Acciaio zincato
 Zinc plated steel
 Stahl Verzinkt

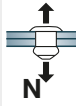
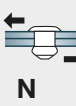

d mm	L mm	D mm							Cod. Art. Item code	€ per 1.000	
3	6	6	3,1	0,5÷3	1240	980	1.000	12.000	113 3006	17,60	
	8			3÷5			1.000	8.000		3008	19,70
	10			5÷7			1.000	8.000		3010	21,40
	12			7÷9			1.000	8.000		3012	24,00
3,2	6	6,5	3,3	0,5÷3	1590	1220	1.000	8.000	113 3206	18,80	
	8			3÷5			1.000	8.000		3208	22,40
	10			5÷7			1.000	8.000		3210	24,80
	12			7÷9			1.000	8.000		3212	29,40
4	6	8	4,1	0,5÷2,5	2800	1900	1.000	8.000	113 4006	19,70	
	8			2,5÷4,5			1.000	8.000		4008	22,40
	10			4,5÷6,5			1.000	8.000		4010	28,00
	12			6,5÷8,5			1.000	8.000		4012	32,20
	14			8,5÷10,5			1.000	8.000		4014	33,90
	16			10,5÷12,5			500	4.000		4016	34,90
	18			12,5÷14,5			500	4.000		4018	37,10
	20			14,5÷16,5			500	4.000		4020	40,00
	24			16,5÷20			500	4.000		4024	56,70
	30			20÷26			500	4.000		4030	83,80
4,8	6	9,5	5	0,5÷2	3600	2800	500	4.000	113 4806	28,20	
	8			2÷4			500	4.000		4808	31,30
	10			4÷6			500	4.000		4810	34,90
	12			6÷8			500	4.000		4812	37,20
	14			8÷10			500	4.000		4814	45,30
	16			10÷12			500	4.000		4816	51,10
	18			12÷14			500	4.000		4818	56,70
	20			14÷16			500	4.000		4820	60,00
	24			16÷20			250	2.000		4824	78,00
	30			20÷26			250	2.000		4830	117,10
6	10	12	6,1	2÷5	6100	4450	250	2.000	113 6010	58,10	
	12			4÷7			250	2.000		6012	60,50
	15			7÷10			250	2.000		6015	67,20
	18			10÷13			250	2.000		6018	76,20
	22			13÷17			250	2.000		6022	81,00
	26			17÷21			250	2.000		6026	101,20
	30			21÷25			-	1.000		6030	130,20
6,4	12	13	6,5	4÷6	6490	5160	250	2.000	113 6412	70,50	
	15			7÷10			250	2.000		6415	75,60
	18			10÷13			250	2.000		6418	84,30
	22			13÷17			250	2.000		6422	87,00
	26			17÷21			250	2.000		6426	114,00
	30			21÷25			-	1.000		6430	134,90

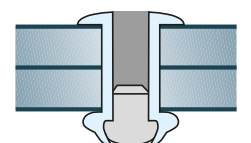
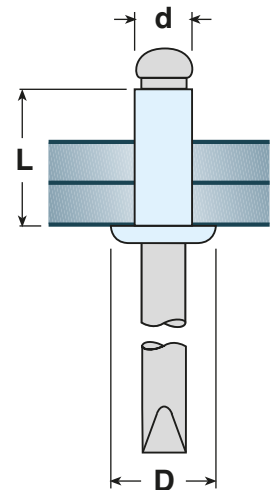

RIVETTI IN RAME CON CHIODO IN ACCIAIO ZINCATO

COPPER RIVETS - ZINC PLATED STEEL NAIL

KUPFER BLINDNIETE MIT NIETDORN AUS STAHL VERZINKT

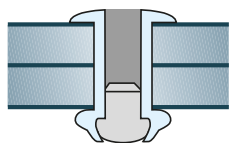
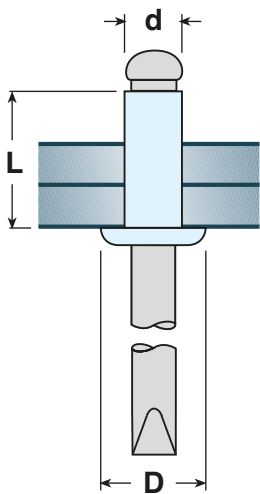
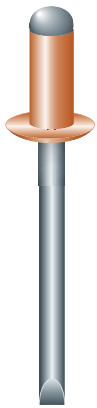

d mm	L mm	D mm	mm	mm	N	N			Cod. Art. Item code	€ per 1.000			
3	6	6	3,1	1÷3	990	650			115 3006	24,00			
	7			3÷4						1.000	12.000	3007	26,00
	9			4÷6						1.000	8.000	3009	27,80
	11			6÷8						1.000	8.000	3011	32,50
	14			8÷11						1.000	8.000	3014	36,40
3,2	6	6,5	3,3	1÷3	1190	880			115 3206	30,70			
	7			3÷4						1.000	8.000	3207	32,00
	9			4÷6						1.000	8.000	3209	33,40
	11			6÷8						1.000	8.000	3211	38,40
3,4	6	7	3,5	1÷3	1390	980			115 3406	37,00			
	7			3÷4						1.000	8.000	3407	38,00
	9			4÷6						1.000	8.000	3409	40,00
	11			6÷8						1.000	8.000	3411	45,80
	14			8÷11						1.000	8.000	3414	51,60
	16			11÷13						1.000	8.000	3416	56,00
4	6	8	4,1	0,5÷2,5	1790	1290			115 4006	46,40			
	7			2,5÷3,5						1.000	8.000	4007	49,00
	9			3,5÷5,5						1.000	8.000	4009	55,20
	11			5,5÷7,5						1.000	8.000	4011	61,20
	12			7,5÷8,5						1.000	8.000	4012	64,50
	14			8,5÷10,5						1.000	8.000	4014	69,40
	16			10,5÷12,5						500	4.000	4016	77,70
	18			12,5÷14,5						500	4.000	4018	79,60
	20			14,5÷16,5						500	4.000	4020	86,80
4,8	8	9,5	5	2÷4	2740	1930			115 4808	76,10			
	10			4÷6						500	4.000	4810	80,50
	12			6÷8						500	4.000	4812	90,10
	14			8÷10						500	4.000	4814	101,00
	16			10÷12						500	4.000	4816	105,00
	18			12÷14						500	4.000	4818	116,80
	20			14÷16						500	4.000	4820	125,00
	24			16÷20						500	4.000	4824	145,60
	30			20÷26						250	2.000	4830	172,00

RIVETTI IN RAME CON CHIUDO IN OTTONE

COPPER RIVETS - BRASS NAIL

KUPFER BLINDNIETE MIT NIETDORN AUS MESSING

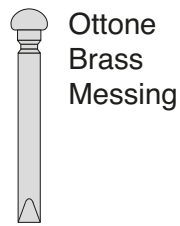

d mm	L mm	D mm							Cod. Art. Item code	€ per 1.000	
			mm	mm	N	N					
3,2	6	6,5	3,3	1÷3	1190	880			117 3206	55,30	
	7			3÷4						1.000 8.000	58,10
	9			4÷6						1.000 8.000	60,60
	11			6÷8						1.000 8.000	68,50
3,4	6	7	3,5	1÷3	1370	980		117 3406	72,90		
	7			3÷4					1.000 8.000	77,90	
	9			4÷6					1.000 8.000	84,70	
	11			6÷8					1.000 8.000	90,30	
4	6	8	4,1	1÷2	1760	1290		117 4006	88,50		
	7			2÷3					1.000 8.000	91,70	
	9			3÷5					1.000 8.000	105,20	
	11			5÷7					1.000 8.000	110,40	

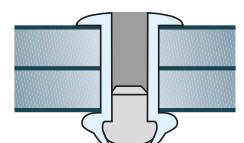
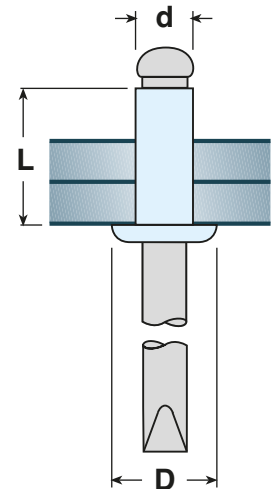





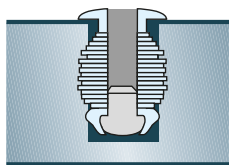
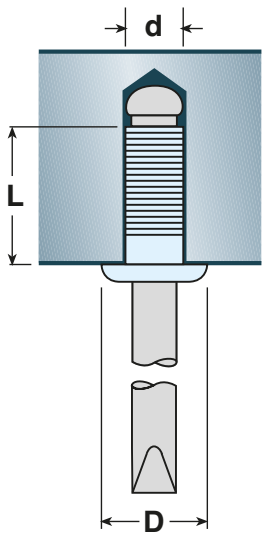
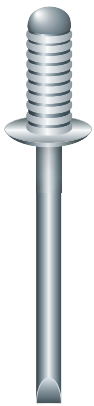

RIVETTI RULLATI IN ALLUMINIO

GROOVED BLIND ALUMINIUM RIVETS

BLINDNIETE GERILLT ALU



d mm	L mm	D mm	 mm	 mm	 N	 N			Cod. Art. Item code	€ per 1.000		
4	8	8	4,3		1850	1300	1.000	8.000	119 4008	20,60		
	12						1.000	8.000			4012	27,00
	16						500	4.000			4016	30,80
4,8	10	9,5	5,1		2950	2170	500	4.000	119 4810	27,80		
	12						500	4.000			4812	30,50
	14						500	4.000			4814	37,20
	18						500	4.000			4818	47,90
	20						500	4.000			4820	52,30
	26						500	4.000			4826	59,20

RIVETTI GRAF IN ALLUMINIO

PEEL RIVETS - ALUMINIUM

SPREIZ ALU BLINDNIETE

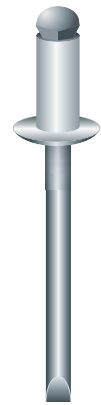

d mm	L mm	D mm							Cod. Art. Item code	€ per 1.000
4	12	8	4,3	3÷6	1850	1300	1.000	8.000	121 4012	32,00
	16			6÷10			500	4.000	4016	37,00
	20			10÷14			500	4.000	4020	41,80
	25			14÷18			500	4.000	4026	52,00
	30			18÷24			500	4.000	4030	69,30
4,8	12	9,5	5,3	2÷6	2950	2170	500	4.000	121 4812	38,00
	16			6÷10			500	4.000	4816	51,10
	20			10÷14			500	4.000	4820	62,60
	26			14÷18			250	2.000	4826	71,30
	30			18÷22			250	2.000	4830	79,20
	35			22÷27			250	2.000	4835	91,60
	40			27÷32			250	2.000	4840	109,00
	45			30÷35			250	2.000	4845	131,00
	50			37÷42			250	2.000	4850	148,20

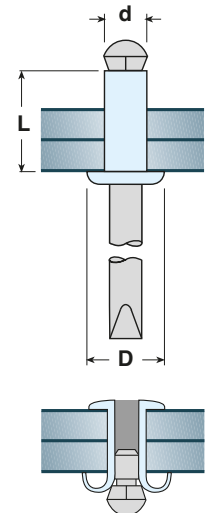

RIVETTI GRAF IN ALLUMINIO - TESTA LARGA

PEEL RIVETS - ALUMINIUM - LARGE HEAD

SPREIZ ALU BLINDNIETE - GRÖßKOPF

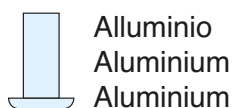

d mm	L mm	D mm							Cod. Art. Item code	€ per 1.000
4	12	10	4,3	2÷6	1850	1300	1.000	8.000	123 4012	40,90
	16			6÷10			500	4.000	4016	47,50
	20			10÷14			500	4.000	4020	53,00
	30			15÷24			500	4.000	4030	85,00
4,8	12	14	5,3	2÷6	2950	2170	500	4.000	123 4812	46,60
	16			6÷10			250	2.000	4816	62,50
	20			10÷14			250	2.000	4820	77,00
	26			14÷18			250	2.000	4826	88,00
	30			18÷22			250	2.000	4830	101,00
	35			22÷27			250	2.000	4835	116,80

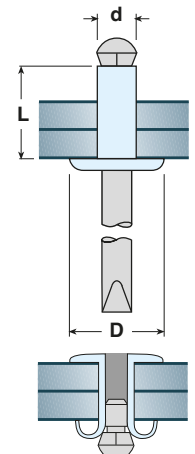

TRIBLOC - RIVETTI TUTTO ALLUMINIO

TRIBLOC - ALUMINIUM / ALUMINIUM RIVETS

TRIBLOC - ALU/ALU BLINDNIETE

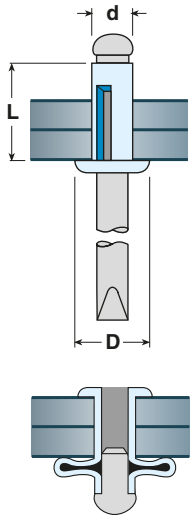
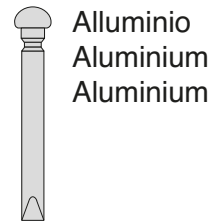

d mm	L mm	D mm								Cod. Art. Item code	€ per 1.000		
4	13,6	8	4,2	1-3	1000	500	500	4.000	125	4013	60,00		
	18,8			3-7						500	4.000	4018	68,60
	24,5			4-12						500	4.000	4024	78,80
4,8	15,3	9,8	5	1-4	1200	900	500	4.000	125	4815	75,00		
	20,5			2-9						250	2.000	4820	81,80
	24,5			4-12						250	2.000	4824	94,00
	27			6-15						250	2.000	4827	108,00

TRIBOL - RIVETTI TUTTO ALLUMINIO CON RONDELLA DI NEOPRENE

TRIBOL - ALUMINIUM / ALUMINIUM RIVETS WITH RUBBER WASHER

TRIBOL - ALU/ALU BLINDNIETE MIT GUMMISCHEIBEN

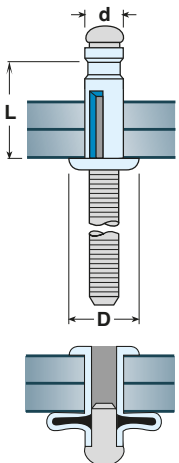
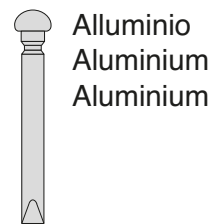
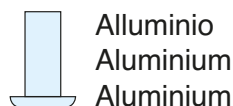

d mm	L mm	D mm							Cod. Art. Item code	€ per 1.000			
5,2	20,0	11,50	5,3-5,6	1,5-7,5	1820	2950	250	2.000	126	5220	300,00		
	22,0			4,5-9,5						250	2.000	5222	316,00
	26,0			7,5-13						250	2.000	5226	327,00
6,4	23,5	14,00	6,5-6,7	1,5-6,5	2450	3900		1.000	126	6424	-		
7,8	28,0	19,00	7,9-8,3	1,5-9,5	4200	6480		1.000	126	7828	-		

RIVETTI TUTTO ACCIAIO INOX A2

STAINLESS STEEL RIVETS A2

EDELSTAHL BLINDNIETE A2

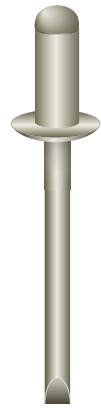

d mm	L mm	D mm						Cod. Art. Item code	€ per 1.000			
3	6	6	3,1	0,5÷3	1950	1850		129 3006	55,20			
	8			3÷5					1.000	8.000	3008	59,30
	10			5÷7					1.000	8.000	3010	64,90
	12			7÷9					1.000	8.000	3012	81,60
3,2	6	6,5	3,3	0,5÷2,5	2540	2450		129 3206	62,80			
	8			2,5÷4,5					1.000	8.000	3208	65,10
	10			4,5÷6,5					1.000	8.000	3210	70,90
	12			6,5÷8,5					1.000	8.000	3212	90,70
4	6	8	4,1	0,5÷2	3520	3130		129 4006	99,50			
	8			2÷4					1.000	8.000	4008	100,50
	10			4÷6					1.000	8.000	4010	109,30
	12			6÷8					1.000	8.000	4012	125,60
	14			8÷10					1.000	8.000	4014	133,70
	16			10÷12					500	4.000	4016	153,50
	20			13÷16					500	4.000	4020	195,30
4,8	8	9	5	1,5÷3,5	5780	4312		129 4808	151,20			
	10			3,5÷5,5					500	4.000	4810	166,70
	12			5,5÷7,5					500	4.000	4812	186,00
	14			7,5÷9,5					500	4.000	4814	202,10
	16			9,5÷11,5					500	4.000	4816	212,80
	18			11,5÷13,5					500	4.000	4818	232,60
	20			13,5÷15,5					500	4.000	4820	244,20
6,4	12	12	6,5	4÷7	9800	7500		129 6412	418,60			
	15			7÷10					250	2.000	6415	493,00
	18			10÷13					250	2.000	6418	503,50
	22			13÷17					250	2.000	6422	567,40

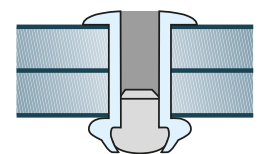
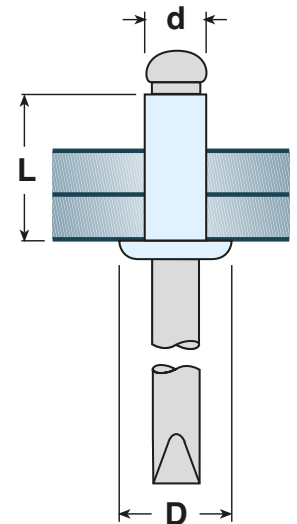

* Disponibili a richiesta anche a testa svasata e in acciaio inox A4.

* Available on request countersunk and stainless steel A4.

TESTA LARGA

LARGE HEAD

GRÖßKOPF

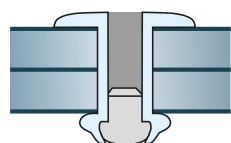
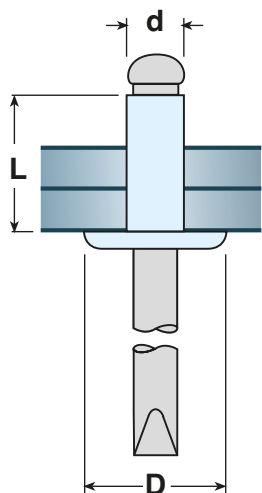
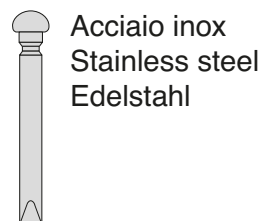
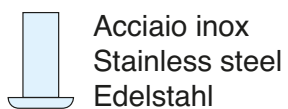

d mm	L mm	D mm	mm	mm	N	N			Cod. Art. Item code	€ per 1.000
4	10	12	4,1	4-6	3520	3130	500	4.000	1294010T12	153,50
4,8	10	14	5	3,5-5,5	5780	4310	500	4.000	1294810T14	218,6
	12			5,5-7,5			500	4.000	4812T14	234,9
	14			7,5-9,5			500	4.000	4814T14	255,8
	16			9,5-11,5			250	2.000	4816T14	288,4
	18			11,5-13,5			250	2.000	4818T14	314,0
	20			13,5-15,5			250	2.000	4820T14	348,8

RIVETTI UNIGRIP IN ALLUMINIO - TESTA CILINDRICA



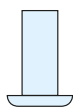

ALUMINIUM UNIGRIP RIVETS - DOMED HEAD

ALU UNIGRIP - BLINDNIETE FLACHRUNDKOPF

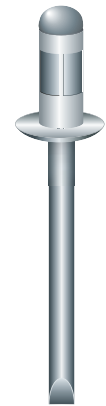
 Alluminio
 Aluminium
 Aluminium

 Acciaio zincato
 Zinc plated steel
 Stahl Verzinkt

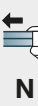

d mm	L mm	D mm	 mm	 mm	 N	 N			Cod. Art. Item code	€ per 1.000								
3	7	6	3,1	1÷4	880	600	1.000	8.000	131 3007	19,30								
3,2	8	6,5	3,4	1÷5	950	640	1.000	8.000	131 3208	19,70								
	9,5			2÷6,5							1.000	8.000	3295	20,80				
	11,5			4÷8							1.000	8.000	3211	22,60				
4	10	8	4,2	1÷6	1660	1220	1.000	8.000	131 4010	23,00								
	13			4÷9							1.000	8.000	4013	29,20				
	17			7÷13							500	4.000	4017	34,50				
4,8	11	10	5,1	1÷6	2250	1610	500	4.000	131 4811	28,70								
	15			5÷10							500	4.000	4815	33,50				
	17			6÷12											500	4.000	4817	41,00
	25			13÷20														

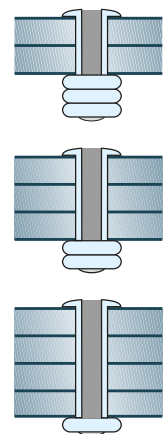
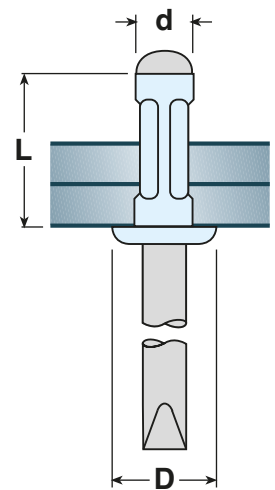

RIVETTI UNIGRIP IN ACCIAIO - TESTA CILINDRICA

STEEL UNIGRIP RIVETS - DOMED HEAD

STAHL UNIGRIP - BLINDNIETE FLACHRUNDKOPF

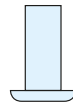
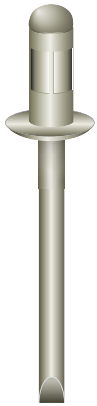





Acciaio zincato
Zinc plated steel
Stahl Verzinkt

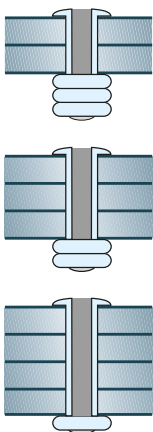
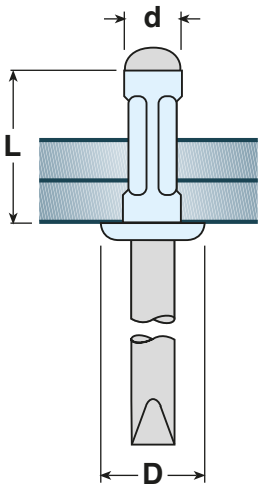

Acciaio zincato
Zinc plated steel
Stahl Verzinkt

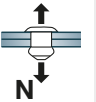
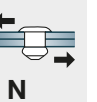
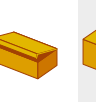

d mm	L mm	D mm	 mm	 mm	 N	 N			Cod. Art. Item code	€ per 1.000
3,2	10	6,5	3,4	1÷4	1280	1370	1.000	8.000	132 3210	28,50
4	11	8	4,2	1,5÷5	2300	2420	1.000	8.000	132 4011	32,80
4,8	11 14	10	5,1	1,2÷4,8 4÷8,5	2830	3100	500 500	4.000 4.000	132 4811 4814	43,00 61,90

RIVETTI UNIGRIP IN ALLUMINIO - TESTA SVASATA 120°

ALUMINIUM UNIGRIP RIVETS - COUNTERSUNK HEAD

ALU UNIGRIP BLINDNIETE - SENKKOPF

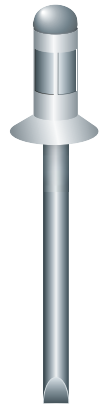

d mm	L mm	D mm							Cod. Art. Item code	€ per 1.000
			mm	mm	N	N				
3,2	10	6	3,4	2,4÷6,4	950	640	1.000	12.000	133 3210	27,20
4	11	7,5	4,2	2,8÷7,9	1660	1220	1.000	8.000	133 4011	34,40
4,8	11 17	8,0	5,1	3,2÷7,9 6,4÷12,7	2250	1610	500 500	4.000 4.000	133 4811 4817	38,30 51,20

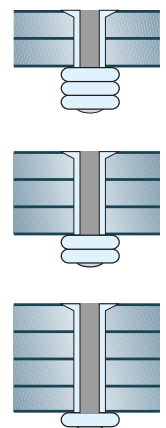
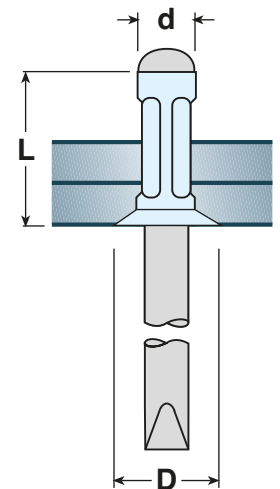







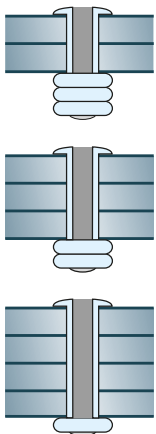
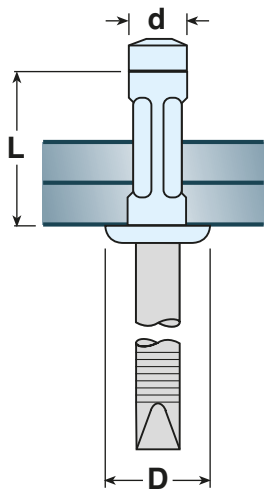
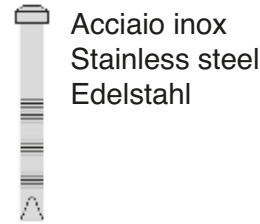
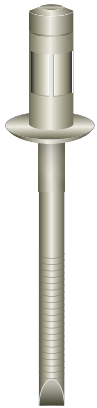





RIVETTI UNIGRIP IN ACCIAIO INOX

STAINLESS STEEL UNIGRIP RIVETS

EDELSTAHL UNIGRIP BLINDNIETE



d mm	L mm	D mm	 mm	 mm	 N	 N			Cod. Art. Item code	€ per 1.000				
3,2	7	6,5	3,4	1÷3	2600	2000			134 3207	85,00				
	9			3÷5							1.000	8.000	3209	94,00
	11			5÷7							1.000	8.000	3211	112,00
4	7	8	4,2	1,2÷3	3600	3000			134 4007	114,00				
	9			3÷5							500	4.000	4009	140,00
	12			5÷7							500	4.000	4012	155,00
	14			7÷9							500	4.000	4014	178,00
4,8	9	10	5,1	1,5÷3,5	5000	4200			134 4809	239,00				
	12			3,5÷6							500	4.000	4812	267,00
	15			6÷8,5							500	4.000	4815	283,00
	18			9÷12,5							500	4.000	4818	312,00

RIVETTI UNIGRIP IN ALLUMINIO - TESTA LARGA

ALUMINIUM UNIGRIP RIVETS - LARGE HEAD

ALU UNIGRIP BLINDNIETE - GRÖßKOPF



d mm	L mm	D mm							Cod. Art. Item code		€ per 1.000
			mm	mm	N	N					
4,8	10			1,6÷6,4			250	2.000	135	4810	46,40
	16	16	5,1	6÷12	2250	1610	250	2.000		4816	56,20
	25			12÷20			250	2.000		4825	71,60

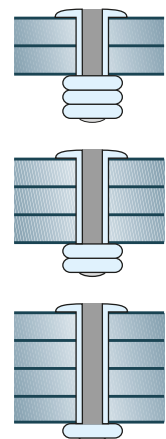
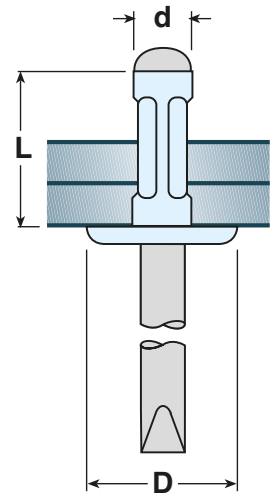

RIVETTI UNIGRIP IN ALLUMINIO - CHiodo INOX

ALUMINIUM UNIGRIP RIVETS - STAINLESS NAIL

ALU UNIGRIP BLINDNIETE - NIETDORN EDELSTAHL

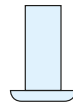





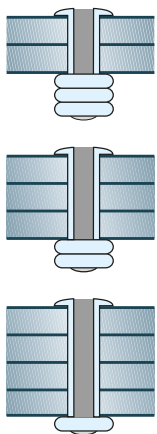
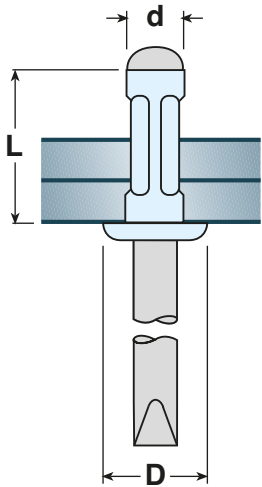

Alluminio
Aluminium
Aluminium



Acciaio inox
Stainless steel
Edelstahl





d mm	L mm	D mm	 mm	 mm	 N	 N			Cod. Art. Item code	€ per 1.000		
3,2	8	6,5	3,4	0,8÷5	1070	880	1.000	8.000	137 3208	48,20		
	9,5			2÷6,5			1.000	8.000			3295	52,60
	11,5			4÷8			1.000	8.000			3211	55,30
4	10	8	4,2	1÷6	1660	1220	1.000	8.000	137 4010	68,40		
	13			4÷9			1.000	8.000			4013	74,70
	17			7÷13			500	4.000			4017	81,10
4,8	11	10	5,1	1÷6	2250	1610	500	4.000	137 4811	100,00		
	15			5÷10			500	4.000			4815	110,50
	17			6÷12			500	4.000			4817	115,20
	25			13÷20			500	4.000			4825	138,90

RIVETTI TENUTA STAGNA



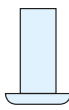

ALUMINIUM SEALED RIVETS

LUFT-WASSERDICHTE ALU BLINDNIETE

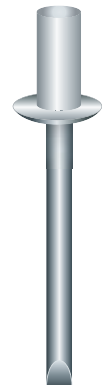
 Alluminio
 Aluminium
 Aluminium

 Acciaio
 Steel
 Stahl

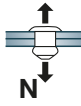
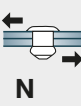

d mm	L mm	D mm	 mm	 mm	 N	 N			Cod. Art. Item code	€ per 1.000	
3,2	6,5	6	3,3	1÷2	1370	1020	1.000	8.000	139 3206	23,30	
	8			2÷3,5			1.000	8.000		3208	24,20
	9,5			3,5÷5			1.000	8.000		3209	25,00
	10,7			5÷6,5			1.000	8.000		3211	27,30
	12,7			6,5÷8			1.000	8.000		3213	30,20
4	8	8	4,1	1÷3,5	2150	1510	1.000	8.000	139 4008	31,80	
	9,5			3,5÷5,0			1.000	8.000		4010	33,50
	11			5÷6,5			1.000	8.000		4011	34,00
	13			6,5÷8			1.000	8.000		4013	34,90
	15			8÷10			500	4.000		4015	41,00
4,8	8	9,5	5	1÷3,5	3030	2050	500	4.000	139 4808	38,40	
	10			3,5÷5,0			500	4.000		4810	42,00
	11			5÷6,5			500	4.000		4811	44,00
	12,5			6,5÷7,5			500	4.000		4812	45,20
	15			7,5÷10			500	4.000		4815	47,70
	18			10÷13			500	4.000		4818	57,40
	22			13÷16			500	4.000		4822	62,50

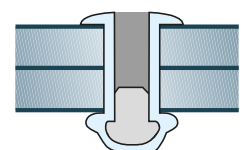
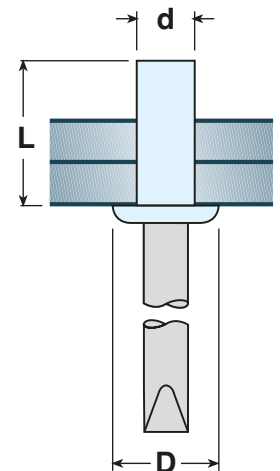

RIVETTI TENUTA STAGNA IN RAME

COPPER SEALED RIVETS

LUFT-WASSERDICHTE KUPFER BLINDNIETE

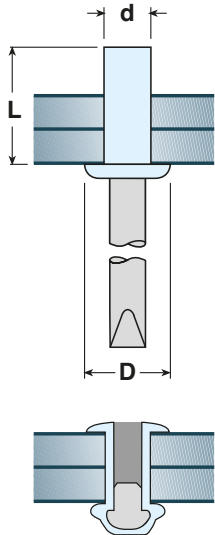
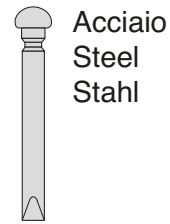
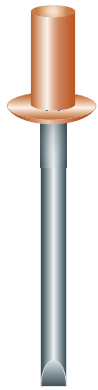

d mm	L mm	D mm	mm	mm	N	N			Cod. Art. Item code	€ per 1.000				
3,2	8	6	3,3	1÷3,5	1370	980	1.000	8.000	141 3208	61,20				
	9			3,5÷4,5							1.000	8.000	3209	68,80
	12			4,5÷8										
4	8	8	4,1	1÷3,5	2000	1420	1.000	8.000	141 4008	106,00				
	10			3,5÷5							1.000	8.000	4010	115,60
4,8	9	9,5	5	1÷5	3030	2050	500	8.000	141 4809	154,00				
	11			5÷6,5							500	8.000	4811	169,00

RIVETTI TENUTA STAGNA IN ACCIAIO INOX

STAINLESS STEEL SEALED RIVETS

LUFT-WASSERDICHTE EDELSTAHL BLINDNIETE

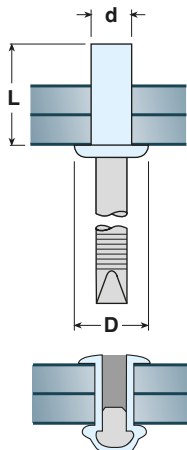

d mm	L mm	D mm	mm	mm	N	N			Cod. Art. Item code	€ per 1.000				
3,2	8	6	3,3	1,5-3,5	2400	1900	1.000	8.000	142 3208	118,00				
	10			3-5							1.000	8.000	4008	136,00
4	12	8	4,1	5-7	3900	2900	1.000	8.000	142 4010	146,00				
	8			3-5							1.000	8.000	4012	154,00
	10			5-7										
4,8	10	9,5	4,9	3-5	5400	4400	500	4.000	142 4812	246,00				
	12			5-7							500	4.000	4812	246,00

RIVETTO MASSA

EARTHER RIVET

ERDUNG BLINDNIETE



Rame
Copper
Kupfer



Acciaio ramato
Copper plated steel
Verkupft Stahl



Ottone
Brass
Messing

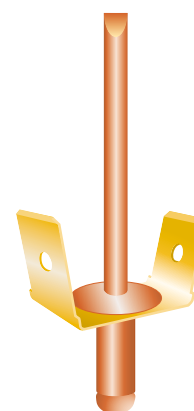

D mm	L mm	Foro Hole mm	↓ ↑ mm	Terminali Terminals	Cod. Art. Item code	100	€ per 1.000	4.000	€ per 1.000
4	6	5,4	0,8÷1,5	1	100007190	100	202,00	4.000	185,00
4	6	5,4	0,8÷1,5	2	100007290	100	228,00	3.000	210,00
4	6	5,4	0,8÷1,5	4	100007490	100	288,00	1.500	270,00



Rame
Copper
Kupfer



Acciaio zincato
Zinc plated steel
Verzinkt Stahl



Ottone
Brass
Messing

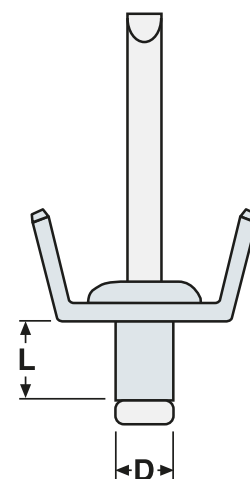

D mm	L mm	Foro Hole mm	↓ ↑ mm	Terminali Terminals	Cod. Art. Item code	100	€ per 1.000	4.000	€ per 1.000
4	6	5,4	0,8÷1,5	1	1000071Z	100	186,00	4.000	170,00
4	6	5,4	0,8÷1,5	2	1000072Z	100	214,00	3.000	194,50
4	6	5,4	0,8÷1,5	4	1000074Z	100	276,00	1.500	254,00

Il rivetto massa è il sistema più rapido per effettuare dei collegamenti di messa a terra su strutture metalliche. Viene prodotto in tre versioni: a 1, 2, 4 terminali. Le dimensioni dei terminali sono 6,3x0,8 e sono conformi alla norma DIN EN 61210 (VDE 0613 P. 6).

I test effettuati confermano che, applicando una corrente di 25 A tra la lamiera ed i due poli, la resistenza è inferiore a 0,2 mhom e tra la lamiera ed i terminali è inferiore a 0,6 mhom. Questi risultati sono ottenibili applicando il rivetto anche su componenti trattati superficialmente.

The earther rivet is the speediest method to effect grounding connections on metal structures. This rivet is produced in three versions: with 1, 2, 4 terminals. The sizes of the terminals are 6,3x0,8 according to the normative DIN EN 61210 (VDE 0613 P. 6).

Test effected on this product confirm that, with electricity 25 A between the metal sheet and the two poles the resistance is less than 0,2 mhom and between the metal sheet and terminals is less than 0,6 mhom. This resultants could be obtained also applying the rivet on components which surface has been treated.

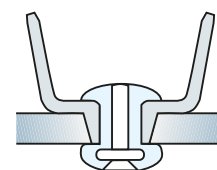

RIVETTO STRUTTURALE UNIBOLT IN ACCIAIO ZINCATO TESTA CILINDRICA

ROUND HEAD ZINC PLATED STEEL UNIBOLT RIVET

UNIBOLT BLINDNIET AUS VERZINKTEM STAHL MIT FLACHKOPF

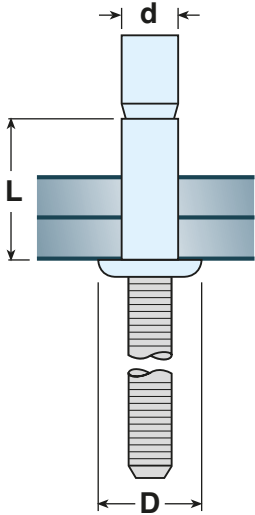
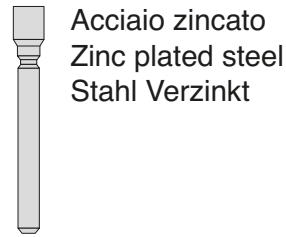
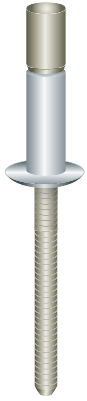

d mm	L mm	D mm	mm	mm	N	N			Cod. Art. Item code	€ per 1.000
4,8	10,5	10	4,9÷5,1	1,6÷6-7	4350	6400	500	4.000	1134810MB 4814MB	165,00 180,00
	14			1,6÷11						
6,4	15	13	6,6÷6,9	2÷10	8060	10700	250	2.000	1136415MB 6420MB	227,00 245,00
	20			2÷16						

*** A richiesta possiamo fornire rivetti in acciaio inox**

RIVETTO STRUTTURALE UNIBOLT IN ACCIAIO ZINCATO TESTA SVASATA

COUNTERSUNK HEAD ZINC PLATED STEEL STRUCTURAL RIVET

STRUKTURELLER BLINDNIET AUS VERZINKTEM STAHL MIT SENKKOPF

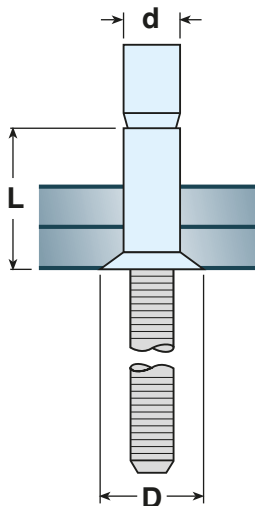
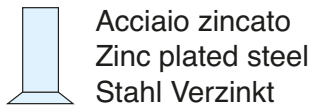
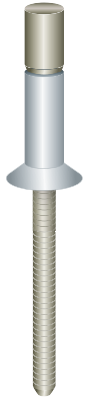

d mm	L mm	D mm	mm	mm	N	N			Cod. Art. Item code	€ per 1.000
4,8	12	8,5	4,9-5,1	3-8	4350	6400	500	4.000	1134812MBTS 1134816MBTS	190,00 206,00
	16			3-12						
6,4	17	10	6,6-7	3-12	8060	10700	250	2.000	1136417MBTS	274,00

RIVETTI UNIBULB IN ACCIAIO - TESTA CILINDRICA





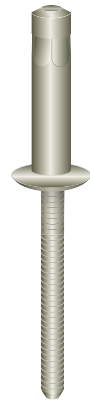

STEEL UNIBULB RIVETS - DOMED HEAD

STAHL UNILBULB - BLINDNIETE FLACHRUNDKOPF

 Acciaio zincato
 Zinc plated steel
 Stahl Verzinkt

 Acciaio zincato
 Zinc plated steel
 Stahl Verzinkt



d mm	L mm	D mm	 mm	 mm	 N	 N			Cod. Art. Item code
3,2	7,0	6,5	3,4	1÷3	1400	2.400	1.000	8.000	144 3207AV 3209AV 3211AV
	9,0			3÷5			1.000	8.000	
	11,0			5÷7			1.000	8.000	
4	7,0	8	4,2	1÷3	2400	5.000	1.000	8.000	144 4007AV 4009AV 4012AV
	9,0			3÷5			1.000	8.000	
	12,0			5÷7			1.000	8.000	
4,8	9,0	10	5,0	1,5÷3,5	3500	5.500	500	4.000	144 4809AV 4812AV 4815AV
	12,0			3,5÷6			500	4.000	
	15,0			6÷8,5			500	4.000	
6	12,0	12	6,2	3-6	5200	7.000	-	1.000	144 6012AV 6015AV
	15,0			6-9			-	1.000	
6,4	12,0	13	6,8	1,5-5,5	6300	9.200	-	1.000	144 6412AV 6416AV 6420AV
	16,0			5-9			-	1.000	
	20,0			8-13			-	1.000	

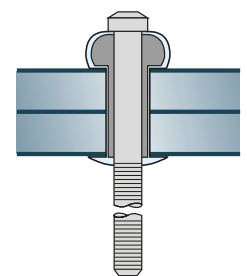
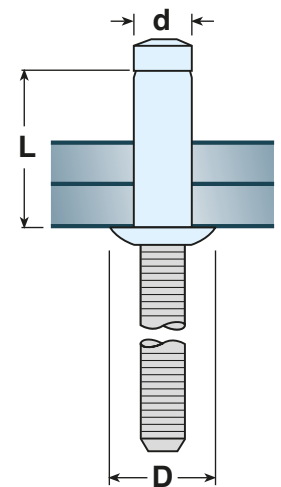

RIVETTI IN ALLUMINIO VERNICIATI CHiodo ACCIAIO ZINCATO



PAINTED ALUMINIUM RIVETS ZINC PLATED NAIL

LACKIERTE ALU BLINDNIETE MIT NIETDORN AUS STAHL

BIANCO RAL 9010

WHITE
WEIß





Articolo Bianco	d x L			€ / 1.000
1013008 9010	3 x 8	1.000	12.000	27,10
1013010 9010	3 x 10	1.000	12.000	28,40
1013012 9010	3 x 12	1.000	12.000	30,00
1013208 9010	3,2 x 8	1.000	12.000	26,50
1013210 9010	3,2 x 10	1.000	8.000	28,10
1013212 9010	3,2 x 12	1.000	8.000	30,30
1014008 9010	4 x 8	1.000	8.000	30,20
1014010 9010	4 x 10	1.000	8.000	32,30
1014012 9010	4 x 12	1.000	8.000	35,20
1014014 9010	4 x 14	1.000	8.000	36,30
1014016 9010	4 x 16	500	4.000	46,20
1014808 9010	4,8 x 8	1.000	8.000	35,50
1014810 9010	4,8 x 10	500	4.000	38,20
1014812 9010	4,8 x 12	500	4.000	40,60
1014814 9010	4,8 x 14	500	4.000	42,60
1014816 9010	4,8 x 16	500	4.000	49,40

NERO RAL 9005

BLACK
SCHWARZ



Articolo Nero	d x L			€ / 1.000
1013008 9005	3 x 8	1.000	12.000	27,10
1013010 9005	3 x 10	1.000	12.000	28,40
1013012 9005	3 x 12	1.000	12.000	30,00
1013208 9005	3,2 x 8	1.000	12.000	26,50
1013210 9005	3,2 x 10	1.000	8.000	28,10
1013212 9005	3,2 x 12	1.000	8.000	30,30
1014008 9005	4 x 8	1.000	8.000	30,20
1014010 9005	4 x 10	1.000	8.000	32,30
1014012 9005	4 x 12	1.000	8.000	35,20
1014014 9005	4 x 14	1.000	8.000	36,30
1014016 9005	4 x 16	500	4.000	46,20
1014808 9005	4,8 x 8	1.000	8.000	35,50
1014810 9005	4,8 x 10	500	4.000	38,20
1014812 9005	4,8 x 12	500	4.000	40,60
1014814 9005	4,8 x 14	500	4.000	42,60
1014816 9005	4,8 x 16	500	4.000	49,40

SU RICHIESTA: Tutti i rivetti in alluminio standard (codice 101) possono essere verniciati nei colori previsti dalla tabella "RAL", per **quantità minima di 20.000 pezzi**. Per eventuali ordini attenersi alla tabella sottoindicata. Per gli altri codici lotto minimo 50.000 pezzi.

ON REQUEST: We can supply aluminium rivets (cod. 101) painted according to the "RAL" table colours, for **minimum quantity of 20.000 pcs**. For your order, please follow the table here below. For other rivets minimum quantity 50.000 pcs.

AUF WUNSCH: Alle Niete aus Aluminium können in den auf Tafel "RAL" vorgesehenen Farben geliefert werden. Bei eventuellen Bestellungen bitte die Tafel unten befolgen, **Mindestmenge 20.000 Stk**.



D.	Quantità	€ / 1.000	da sommare al prezzo di listino to be added to the gross price dem Listenpreis hinzuzahlen
2,4 - 3,4	> 20.000	19,00	
4,0 - 4,8	> 20.000	21,00	
6,0 - 6,4	> 20.000	23,00	
Anodizzazione nera Black anodizing		58,00	

RIVETTI IN ALLUMINIO VERNICIATI CHiodo ACCIAIO ZINCATO

PAINTED ALUMINIUM RIVETS ZINC PLATED NAIL

LACKIERTE ALU BLINDNIETE MIT NIETDORN AUS STAHL

COLORI VARI

VARIOUS COLOURS

VERSCHIEDENEN FARBEN



Articolo	d x L		RAL	colore	€ / 1.000
10130108017	3 x 10	1.000	8017	marrone	28,40
10132088017	3,2 x 8	1.000	8017	marrone	26,50
10134078017	3,4 x 7	1.000	8017	marrone	28,00
10134098017	3,4 x 9	1.000	8017	marrone	29,60
10140088017	4 x 8	1.000	8017	marrone	30,20
10140108017	4 x 10	1.000	8017	marrone	32,30
10140128017	4 x 12	1.000	8017	marrone	35,20
10148128017	4,8 x 12	500	8017	marrone	40,60



Articolo	d x L		RAL	colore	€ / 1.000
1013010RAME	3 x 10	1.000	RAME	rame	28,40
1013208RAME	3,2 x 8	1.000	RAME	rame	26,50
1013409RAME	3,4 x 9	1.000	RAME	rame	29,60
1014012RAME	4 x 12	1.000	RAME	rame	35,20
1014812RAME	4,8 x 12	500	RAME	rame	40,60



Articolo	d x L		RAL	colore	€ / 1.000
10130109002	3 x 10	1.000	9002	bianco grigio	28,40
10132089002	3,2 x 8	1.000	9002	bianco grigio	26,50
10132129002	3,2 x 12	1.000	9002	bianco grigio	30,30
10134079002	3,4 x 7	1.000	9002	bianco grigio	28,00
10134099002	3,4 x 9	1.000	9002	bianco grigio	29,60
10140089002	4 x 8	1.000	9002	bianco grigio	30,20
10140109002	4 x 10	1.000	9002	bianco grigio	32,30
10140129002	4 x 12	1.000	9002	bianco grigio	35,20
10140149002	4 x 14	1.000	9002	bianco grigio	36,30
10148129002	4,8 x 12	500	9002	bianco grigio	40,60



Articolo	d x L		RAL	colore	€ / 1.000
10140103009	4 x 10	1.000	3002	rosso	34,30
10140106005	4 x 10	1.000	6005	verde	32,30
10548129005	4,8 x 12 testa 14	250	9005	nero	53,40
10748169005	4,8 x 16 testa 16	250	9005	nero	62,80
12248129010	4,8 x 12 graf	500	9010	bianco	59,00
12248125017	4,8 x 12 graf	500	5017	blu targa	59,00
12248129005	4,8 x 12 graf	500	9005	nero	59,00
12348169005	4,8 x 16 testa 14 graf	250	9005	nero	83,50

SCATOLA ESPOSITRICE CON SACCHETTI SELF-SERVICE

SELF-SERVICE PACKAGING



Scatola espositrice contenente rivetti in confezione da 100 pezzi.



I rivetti sono disponibili in lega di alluminio, rame naturale, acciaio inox.



Per la quantità da ordinare attenersi alla tabella.



Possiamo inoltre fornire altre dimensioni non riportate in tabella con quantitativo minimo di 20.000 pezzi.

The exhibitor box contains bags of 100 pieces. This packaging is available for aluminium, copper, stainless steel rivets. Concerning quantities, please make reference to the tables below.

We can pack in bags the rivets which are not included in this tables but only for minimum quantities of 20.000 pieces/size.

d mm	L mm			N° Articolo Alluminio	Alluminio Euro per scatola
3	6	100	1000	145 3006	16,60
	8	100	1000	3008	18,20
	10	100	1000	3010	20,10
	12	100	1000	3012	21,50
3,2	6	100	1000	145 3206	16,70
	8	100	1000	3208	18,20
	10	100	1000	3210	20,00
	12	100	1000	3212	21,80
3,4	7	100	1000	145 3407	18,20
	9	100	1000	3409	20,30
	11	100	1000	3411	22,80
	12	100	1000	3412	23,60
4	14	100	1000	3414	25,00
	6	100	1000	145 4006	18,50
	8	100	1000	4008	20,00
	10	100	1000	4010	22,50
	12	100	1000	4012	26,10
	14	100	1000	4014	27,00
	16	100	1000	4016	29,10
	18	100	1000	4018	30,90
4,8	20	100	1000	4020	32,00
	6	100	1000	145 4806	21,40
	8	100	1000	4808	23,00
	10	100	1000	4810	26,10
	12	100	1000	4812	28,60
	14	100	1000	4814	36,00
	16	100	1000	4816	40,20
	18	100	1000	4818	45,40
20	100	1000	4820	49,30	

d mm	L mm			N° Articolo Rame	Rame Euro per scatola
3	7	100	1000	147 3007	31,00
	9	100	1000	3009	33,00
	11	100	1000	3011	38,50
	14	100	1000	3014	43,40
	7	100	1000	147 3207	38,00
3,2	9	100	1000	3209	39,50
	11	100	1000	3211	45,30
3,4	7	100	1000	147 3407	45,20
	9	100	1000	3409	47,00
	11	100	1000	3411	55,80
4	14	100	1000	3414	60,80
	7	100	1000	147 4007	58,00
	9	100	1000	4009	65,80
	11	100	1000	4011	72,90
	12	100	1000	4012	76,00
4,8	14	100	1000	4014	81,90
	8	100	1000	147 4808	89,80
	10	100	1000	4810	95,00
	12	100	1000	4812	106,40
	14	100	1000	4814	120,00
	16	100	1000	4816	124,00

d mm	L mm			N° Articolo Acciaio inox	Acciaio inox Euro per scatola
3,2	8	100	1000	148 3208	70,80
	10	100	1000	3210	77,60
4	10	100	1000	148 4010	121,70
	12	100	1000	4012	138,20
4,8	10	100	1000	148 4810	181,90
	12	100	1000	4812	199,60



INSERTI FILETTATI
THREADED INSERTS
BLINDEINNIETMUTTERN

INSERTI FILETTATI A TESTA CILINDRICA IN ACCIAIO
THREADED INSERTS CYLINDRICAL HEAD IN STEEL
BLIND-EINNIETMUTTERN-FLACHKOPF AUS STAHL



Acciaio Zincato C4C
 Zinc plated steel C4C
 Stahl Verzinkt C4C

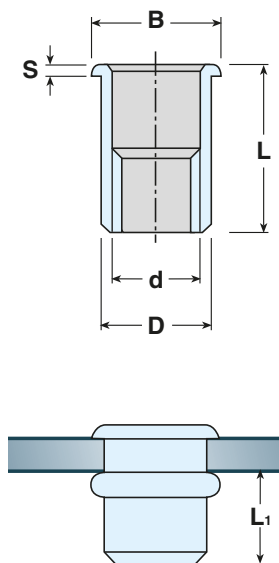

d 6H	D mm	B mm	S mm	mm	mm	L ₁ mm	L mm	Cod. Art. Item code		€ per 1.000		€ per 1.000
M3	4,9	7	0,8	5	0,3÷1,8 1,8÷3,0	4,2÷4,6	9 10,5	32M3 TP-C 32M3 TP-L	200	76,20 76,20	2.500	61,00 61,00
M4	5,9	9	1	6	0,3÷2,5 2,5÷4,0	5,5÷6,0	11 13	32M4 TP-C 32M4 TP-L	200	86,00 86,00	2.500	70,40 70,40
M5	6,9	10	1,2	7	0,5÷3,0 3,0÷5,0	7,2÷7,7	13 15,5	32M5 TP-C 32M5 TP-L	200	96,20 96,20	2.500	75,40 75,40
M6	8,9	12	1,5	9	0,5÷2,3 2,3÷4,0 4,0÷6,0	7,6÷8,2	14,5 16 17,5	32M6 TP-C 32M6 TP-M 32M6 TP-L	200	124,80 124,80 124,80	2.500	93,20 93,20 93,20
M8	10,9	15	1,5	11	0,8÷3,5 3,5÷6,0	9,5÷10,1	17,5 20	32M8 TP-C 32M8 TP-L	200	183,50 183,50	2.500	109,20 109,20
M10	11,9	16	1,7	12	1,0÷3,5 3,5÷6,0	10,7÷11,5	19 22	32M10 TP-C 32M10 TP-L	200	218,40 218,40	2.000	141,50 141,50
M10	12,9	17	1,7	13	1,0÷3,5 3,5÷6,0	12,5÷13,5	21 24	32M10 TP-C13 32M10 TP-L13	200	234,00 234,00	2.000	160,00 160,00

d		
	Trazione (N)	Coppia max serraggio (Nm)
	Acciaio	Acciaio
M3	4.000	1,20
M4	6.000	3,80
M5	10.000	6,00
M6	15.000	11,50
M8	22.500	22,00
M10	26.000	37,00





INSERTI FILETTATI A TESTA SVASATA IN ACCIAIO

THREADED INSERTS COUNTERSUNK HEAD IN STEEL

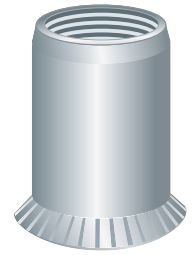
BLIND-EINNIETMUTTERN-SENKKOPF AUS STAHL

Acciaio Zincato C4C
Zinc plated steel C4C
Stahl Verzinkt C4C



d 6H	D mm	B mm	S mm	 mm	 mm	L ₁ mm	L mm	Cod. Art. Item code		€ per 1.000		€ per 1.000
M3	4,9	8	1,5	5	1,5÷3,0 3,0÷4,0	4,7÷5,3	9,5 10,5	32M3 TS-C 32M3 TS-L	200	76,20 76,20	2.500	61,00 61,00
M4	5,9	9	1,5	6	1,5÷3,5 3,5÷5,0	5,8÷6,3	11 13	32M4 TS-C 32M4 TS-L	200	86,00 86,00	2.500	70,40 70,40
M5	6,9	10	1,5	7	1,5÷4,0 4,0÷6,0	6,8÷7,3	13 15	32M5 TS-C 32M5 TS-L	200	96,20 96,20	2.500	75,40 75,40
M6	8,9	12	1,5	9	1,5÷4,0 4,0÷6,0	8,5÷9,2	15 17	32M6 TS-C 32M6 TS-L	200	124,80 124,80	2.500	93,20 93,20
M8	10,9	14	1,5	11	1,5÷4,0 4,0÷6,0	9,5÷10,4	16,5 19	32M8 TS-C 32M8 TS-L	200	183,50 183,50	2.500	109,20 109,20
M10	11,9	15	1,5	12	1,5÷4,0 4,0÷6,0	11÷12	18 20,5	32M10 TS-C 32M10 TS-L	200	218,40 218,40	2.000	141,50 141,50

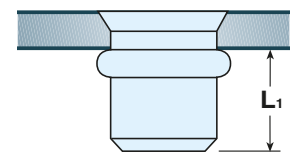
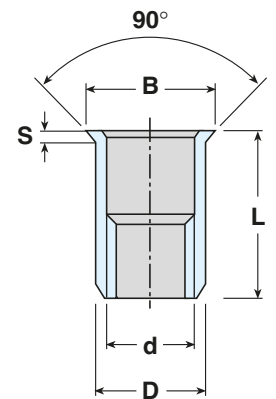

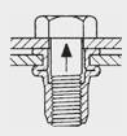
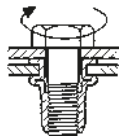
d		
	Trazione (N)	Coppia max serraggio (Nm)
	Acciaio	Acciaio
M3	4.000	1,20
M4	6.000	3,80
M5	10.000	6,00
M6	15.000	11,50
M8	22.500	22,00
M10	26.000	37,00

INSERTI FILETTATI A TESTA RIDOTTA IN ACCIAIO

THREADED INSERTS REDUCED HEAD IN STEEL

BLIND-EINNIETMUTTERN-FLACHKOPF AUS STAHL



Acciaio Zincato C4C
Zinc plated steel C4C
Stahl Verzinkt C4C

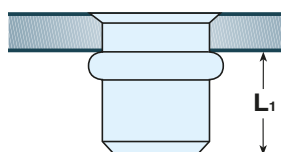
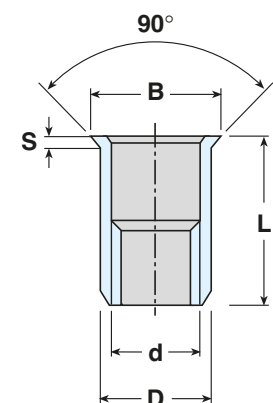

d 6H	D mm	B mm	S mm	mm	mm	L ₁ mm	L mm	Cod. Art. Item code		€ per 1.000		€ per 1.000
M3	4,9	5,5	0,35	5	0,5÷1,5 1,5÷2,5	5,4÷5,8	8,5 9,5	32M3 TSR-C 32M3 TSR-L	200	76,20 76,20	2.500	61,00 61,00
M4	5,9	6,75	0,50	6	0,5÷1,5 1,5÷2,5	6,5÷7,0	10 11	32M4 TSR-C 32M4 TSR-L	200	86,00 86,00	2.500	70,40 70,40
M5	6,9	8	0,60	7	0,5÷2,0 2,0÷3,5	8,0÷8,5	12 13,5	32M5 TSR-C 32M5 TSR-L	200	96,20 96,20	2.500	75,40 75,40
M6	8,9	10	0,60	9	0,5÷2,0 2,0÷3,5	9,0÷9,7	13,5 15	32M6 TSR-C 32M6 TSR-L	200	124,80 124,80	2.500	93,20 93,20
M8	10,9	12	0,60	11	1,0÷2,5 2,5÷4,0	10,7÷11,4	16,5 18	32M8 TSR-C 32M8 TSR-L	200	183,50 183,50	2.500	109,20 109,20
M10	11,9	13,5	0,85	12	1,0÷2,5 2,5÷4,0	12,3÷13,1	18 19,5	32M10 TSR-C 32M10 TSR-L	200	218,40 218,40	2.000	141,50 141,50

d		
	Trazione (N)	Coppia max serraggio (Nm)
	Acciaio	Acciaio
M3	4.000	1,20
M4	6.000	3,80
M5	10.000	6,00
M6	15.000	11,50
M8	22.500	22,00
M10	26.000	37,00

INSERTI FILETTATI CIECHI A TESTA CILINDRICA IN ACCIAIO

THREADED INSERTS CYLINDRICAL HEAD IN STEEL - CLOSED END

BLIND-EINNIETMUTTERN-FLACHKOPF-GESCHLOSSEN AUS STAHL

Acciaio Zincato C4C
Zinc plated steel C4C
Stahl Verzinkt C4C



d 6H	D mm	B mm	S mm			L ₁ mm	L mm	Cod. Art. Item code		€ per 1.000		€ per 1.000
M3	4,9	7	0,8	5	0,3÷1,8 1,8÷3,0	9,8÷10,3	14,5 15,5	32M3 TPC-C 32M3 TPC-L	200	123,00 123,00	2.500	103,50 103,50
M4	5,9	9	1	6	0,3÷2,5 2,5÷4,0	11,3÷12,0	16,5 18	32M4 TPC-C 32M4 TPC-L	200	144,20 144,20	2.500	122,00 122,00
M5	6,9	10	1,2	7	0,5÷3,0 3,0÷5,0	12,3÷13,0	18 20,5	32M5 TPC-C 32M5 TPC-L	200	171,40 171,40	2.500	127,80 127,80
M6	8,9	12	1,5	9	0,5÷3,0 3,0÷6,0	14÷14,5	20,5 23,5	32M6 TPC-C 32M6 TPC-L	200	212,40 212,40	2.500	162,50 162,50
M8	10,9	15	1,5	11	0,8÷3,5 3,5÷6,0	17,5÷18,2	25,5 28	32M8 TPC-C 32M8 TPC-L	200	278,00 278,00	2.000	195,00 195,00
M10	11,9	16	1,7	12	1,0÷3,5 3,5÷6,0	21÷22	29 31,5	32M10 TPC-C 32M10 TPC-L	100	365,50 365,50	1.000	247,00 247,00

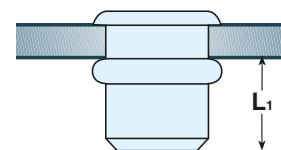
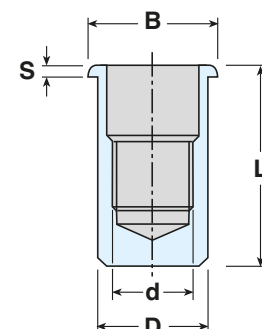

d		
	Trazione (N)	Coppia max serraggio (Nm)
	Acciaio	Acciaio
M3	4.000	1,20
M4	6.000	3,80
M5	10.000	6,00
M6	15.000	11,50
M8	22.500	22,00
M10	26.000	37,00

INSERTI FILETTATI ZIGRINATI A TESTA CILINDRICA IN ACCIAIO

KNURLED THREADED INSERTS CYLINDRICAL HEAD IN STEEL

BLIND-EINNIETMUTTERN-FLACHKOPF RENDELUNG AUS STAHL

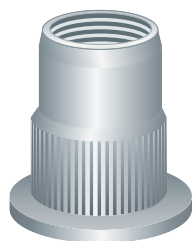

Acciaio Zincato C4C
Zinc plated steel C4C
Stahl Verzinkt C4C

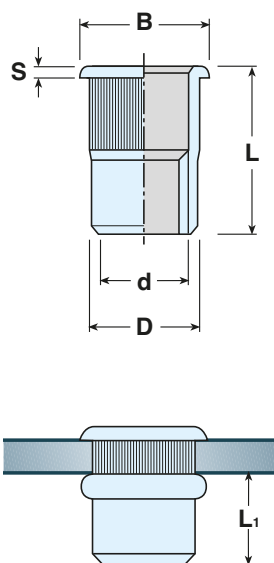





d 6H	D mm	B mm	S mm	mm	mm	L ₁ mm	L mm	Cod. Art. Item code		€ per 1.000		€ per 1.000	
M4	5,9	9	1	6	0,5÷2,5	5,5÷6,0	11	32M4 TPZ-C	200	86,00	2.500	70,40	
					2,5÷3,5		13			32M4 TPZ-L			86,00
M5	6,9	10	1,2	7	0,5÷2,0	7,2÷7,7	13	32M5 TPZ-C	200	96,20	2.500	75,40	
					2,0÷3,5		14,5	32M5 TPZ-M		96,20			75,40
					3,5÷5,0		16	32M5 TPZ-L		96,20			75,40
M6	8,9	12	1,5	9	0,5÷2,0	7,6÷8,2	14,5	32M6 TPZ-C	200	124,80	2.500	93,20	
					2,0÷3,5		16	32M6 TPZ-M		124,80			93,20
					3,5÷5,0		17,5	32M6 TPZ-L		124,80			93,20
M8	10,9	15	1,5	11	1,0÷2,5	9,5÷10,0	17,5	32M8 TPZ-C	200	183,50	2.500	109,20	
					2,5÷4,0		19	32M8 TPZ-M		183,50			109,20
					4,0÷5,5		20,5	32M8 TPZ-L		183,50			109,20
M10	11,9	16	1,7	12	1,0÷3,5	10,5÷11,5	19	32M10 TPZ-C	200	230,00	2.000	160,00	
M10	12,9	17	1,7	13	0,5÷3,0	10,6÷11,5	21	32M10 TPZ-C13	200	234,00	2.000	160,00	
M12	14,9	18	1,9	15	1,0÷3,5	18,0÷18,8	22	32M12 TPZ-C	200	460,00	1.000	350,00	
M12	15,9	22	1,9	16	1,0÷4,0	18,0÷18,8	24	32M12 TPZ-C16	200	469,00	1.000	352,00	

d		
	Trazione (N)	Coppia max serraggio (Nm)
	Acciaio	Acciaio
M4	6.000	3,8
M5	10.000	6,0
M6	15.000	11,5
M8	22.500	22,0
M10	21.000	36,0
M10-13	26.000	37,0
M12	32.000	50,0
M12-16	33.800	53,0

INSERTI FILETTATI ZIGRINATI A TESTA RIDOTTA IN ACCIAIO
KNURLED THREADED INSERTS REDUCED HEAD IN STEEL
BLIND-EINNIETMUTTERN-KLEINKOPF-RENDELUNG AUS STAHL

Acciaio Zincato C4C
 Zinc plated steel C4C
 Stahl Verzinkt C4C



d 6H	D mm	B mm	S mm	 mm	 mm	L ₁ mm	L mm	Cod. Art. Item code		€ per 1.000		€ per 1.000
M4	5,9	6,75	0,5	6	0,5÷1,5 1,5÷2,5	6,5÷7,0	10 11	32M4 TSRZ 32M4 TSRZ-L	200	86,00 86,00	2.500	70,40 70,40
M5	6,9	8	0,6	7	0,5÷2,0 2,0÷3,5	7,5÷8,0	12 13,5	32M5 TSRZ 32M5 TSRZ-L	200	96,20 96,20	2.500	75,40 75,40
M6	8,9	10	0,6	9	0,5÷2,0 2,0÷3,5	9,0÷9,6	13,5 15	32M6 TSRZ 32M6 TSRZ-L	200	124,80 124,80	2.500	93,20 93,20
M8	10,9	12	0,6	11	1,0÷2,5 2,5÷4,0	10,7÷11,4	16,5 18	32M8 TSRZ 32M8 TSRZ-L	200	183,50 183,50	2.500	109,20 109,20
M10	12,9	14	0,9	13	0,5÷3,5	10,5÷11,8	21,0	32M10TSRZ13	200	220,00	2.000	142,00
M12	14,9	17	0,8	15	1,0÷3,5	13,3÷14,5	21,0	32M12 TSRZ	200	460,00	1.000	350,00

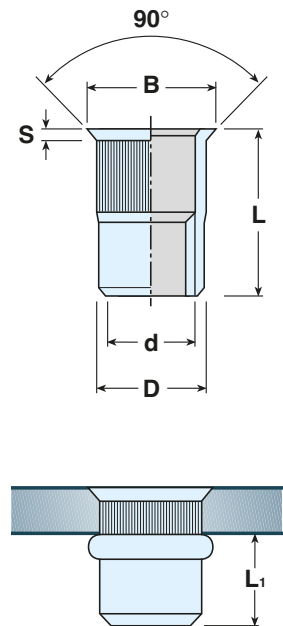

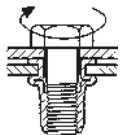
d		
	Trazione (N)	Coppia max serraggio (Nm)
	Acciaio	Acciaio
M4	6.000	3,8
M5	10.000	6,0
M6	15.000	11,5
M8	22.500	22,0
M10	26.000	37,0
M12	32.000	50,0

INSERTI FILETTATI ZIGRINATI A TESTA RIDOTTA IN ACCIAIO

KNURLED THREADED INSERTS REDUCED HEAD IN STEEL

BLIND-EINNIETMUTTERN-KLEINKOPF-RENDELUNG AUS STAHL



Acciaio Zincato C4C
Zinc plated steel C4C
Stahl Verzinkt C4C

* Differiscono dal modello TSRZ nella dimensione del diametro esterno
* Different from TSRZ in the outside diameter dimension

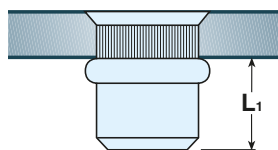
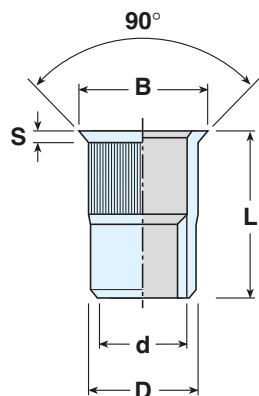

d 6H	D mm	B mm	S mm	mm	mm	L ₁ mm	L mm	Cod. Art. Item code		€ per 1.000		€ per 1.000
M4	6,3	6,9	0,5	6,4	0,5÷1,5	6,3÷6,7	10,5	32M4 TSRZ-PR	200	86,80	2.500	71,50
M5	7,1	7,7	0,5	7,2	0,5÷2,0	7,4÷7,8	12	32M5 TSRZ-PR	200	97,60	2.500	75,70
M6	9,5	10,2	0,5	9,6	0,7÷2,5	8,8÷9,6	13,5	32M6 TSRZ-PR	200	112,00	2.500	84,00
M8	10,5	11,2	0,5	10,6	1,0÷3,0	10÷10,8	16,5	32M8 TSRZ-PR	200	188,30	2.500	112,50

d		
	Trazione (N) Acciaio	Coppia max serraggio (Nm) Acciaio
M4	6.000	3,8
M5	11.000	6,0
M6	15.000	11,5
M8	19.500	22,0





INSERTI FILETTATI A TESTA CILINDRICA IN ALLUMINIO

THREADED INSERTS CYLINDRICAL HEAD IN ALUMINIUM

BLIND-EINNIETMUTTERN-FLACHKOPF AUS ALUMINIUM

Alluminio AIMg 2,5
Aluminium AIMg 2,5
Aluminium AIMg 2,5



d 6H	D mm	B mm	S mm	 mm	 mm	L ₁ mm	L mm	Cod. Art. Item code		€ per 1.000		€ per 1.000
M3	4,9	7	0,8	5	0,3÷1,8 1,8÷3,0	4,2÷4,6	9 10,5	31M3 TP-C 31M3 TP-L	200	86,00 86,00	2.500	66,60 66,60
M4	5,9	9	1	6	0,3÷2,5 2,5÷4,0	5,5÷6,0	11 13	31M4 TP-C 31M4 TP-L	200	97,60 97,60	2.500	73,20 73,20
M5	6,9	10	1,2	7	0,5÷3,0 3,0÷5,0	7,2÷7,7	13 15,5	31M5 TP-C 31M5 TP-L	200	98,50 98,50	2.500	77,80 77,80
M6	8,9	12	1,5	9	0,5÷2,3 2,3÷4,0 4,0÷6,0	7,6÷8,2	14,5 16 17,5	31M6 TP-C 31M6 TP-M 31M6 TP-L	200	138,20 138,20 138,20	2.500	103,00 103,00 103,00
M8	10,9	15	1,5	11	0,8÷3,5 3,5÷6,0	9,5÷10,1	17,5 20	31M8 TP-C 31M8 TP-L	200	189,40 189,40	2.500	123,60 123,60
M10	11,9	16	1,7	12	1,0÷3,5 3,5÷6,0	10,7÷11,5	19 22	31M10 TP-C 31M10 TP-L	200	232,00 232,00	2.000	152,80 152,80

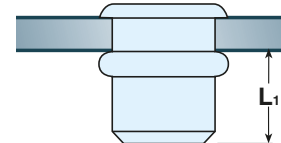
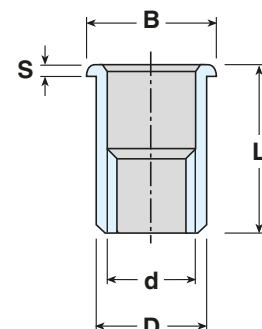

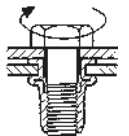
d		
	Trazione (N)	Coppia max serraggio (Nm)
	Alluminio	Alluminio
M3	2.500	0,70
M4	3.700	2,00
M5	5.500	4,00
M6	8.300	7,50
M8	9.700	18,00
M10	13.300	23,00

INSERTI FILETTATI A TESTA SVASATA IN ALLUMINIO
THREADED INSERTS COUNTERSUNK HEAD IN ALUMINIUM
BLIND-EINNIETMUTTERN-SENKKOPF AUS ALUMINIUM



Alluminio AIMg 2,5
 Aluminium AIMg 2,5
 Aluminium AIMg 2,5

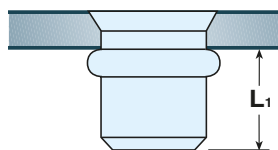
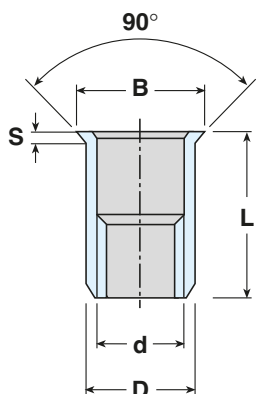

d 6H	D mm	B mm	S mm	mm	mm	L ₁ mm	L mm	Cod. Art. Item code		€ per 1.000		€ per 1.000
M4	5,9	9	1,5	6	2,0÷3,5 3,5÷5,0	5,8÷6,3	11 13	31M4 TS-C 31M4 TS-L	200	97,60 97,60	2.500	73,20 73,20
M5	6,9	10	1,5	7	2,5÷4,0 4,0÷6,0	6,8÷7,3	13 15	31M5 TS-C 31M5 TS-L	200	98,50 98,50	2.500	77,80 77,80
M6	8,9	12	1,5	9	2,5÷4,0 4,0÷6,0	8,5÷9,2	15 17	31M6 TS-C 31M6 TS-L	200	138,20 138,20	2.500	103,00 103,00
M8	10,9	14	1,5	11	2,5÷4,0 4,0÷6,0	9,5÷10,4	16,5 19	31M8 TS-C 31M8 TS-L	200	189,40 189,40	2.500	123,60 123,60
M10	11,9	15	1,5	12	2,5÷4,0 4,0÷6,0	11÷12	18 20,5	31M10 TS-C 31M10 TS-L	200	254,50 254,50	2.000	171,00 171,00

d		
	Trazione (N) Alluminio	Coppia max serraggio (Nm) Alluminio
M3	2.500	0,70
M4	3.700	2,00
M5	5.500	4,00
M6	8.300	7,50
M8	9.700	18,00
M10	13.300	23,00

INSERTI FILETTATI CIECHI A TESTA CILINDRICA IN ALLUMINIO

THREADED INSERTS CYLINDRICAL HEAD IN ALUMINIUM - CLOSED END

BLIND-EINNIETMUTTERN-FLACHKOPF-GESCHLOSSEN AUS ALUMINIUM

Alluminio AIMg 2,5
Aluminium AIMg 2,5
Aluminium AIMg 2,5

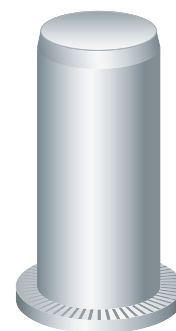

d 6H	D mm	B mm	S mm	mm	mm	L ₁ mm	L mm	Cod. Art. Item code	200	€ per 1.000	2.500	€ per 1.000
M3	4,9	7	0,8	5	0,3÷1,8 1,8÷3,0	9,8÷10,3	14,5 15,5	31M3 TPC-C 31M3 TPC-L	200	134,20 134,20	2.500	115,00 115,00
M4	5,9	9	1	6	0,3÷2,5 2,5÷4,0	11,3÷12,0	16,5 18	31M4 TPC-C 31M4 TPC-L	200	155,00 155,00	2.500	132,20 132,20
M5	6,9	10	1,2	7	0,5÷3,0 3,0÷5,0	12,3÷13,0	18 20,5	31M5 TPC-C 31M5 TPC-L	200	179,60 179,60	2.500	137,80 137,80
M6	8,9	12	1,5	9	0,5÷3,0 3,0÷6,0	14÷14,5	20,5 23,5	31M6 TPC-C 31M6 TPC-L	200	230,00 230,00	2.500	182,80 182,80
M8	10,9	15	1,5	11	0,8÷3,5 3,5÷6,0	17,5÷18,2	25,5 28	31M8 TPC-C 31M8 TPC-L	200	320,00 320,00	2.000	218,00 218,00
M10	11,9	16	1,7	12	1,0÷3,5 3,5÷6,0	21÷22	29 31,5	31M10 TPC-C 31M10 TPC-L	100	406,00 406,00	1.000	260,00 260,00

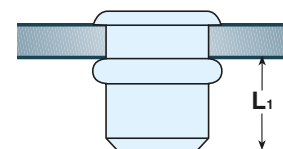
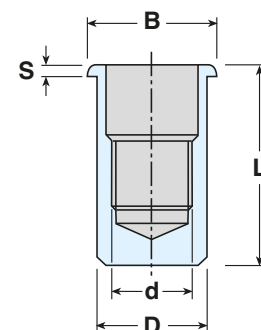

d	Trazione (N)	Coppia max serraggio (Nm)
	Alluminio	Alluminio
M3	2.500	0,70
M4	3.700	2,00
M5	5.500	4,00
M6	8.300	7,50
M8	9.700	18,00
M10	13.300	23,00

INSERTI FILETTATI ZIGRINATI A TESTA CILINDRICA IN ACCIAIO INOX
KNURLED THREADED INSERTS CYLINDRICAL HEAD STAINLESS STEEL
BLIND-EINNIETMUTTERN-FLACHKOPF AUS EDELSTAHL

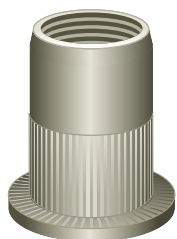

Acciaio inox AISI 304 Cu
 Stainless steel AISI 304 Cu
 Edelstahl AISI 304 Cu

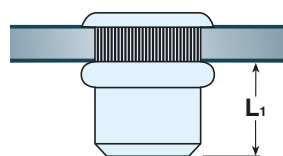
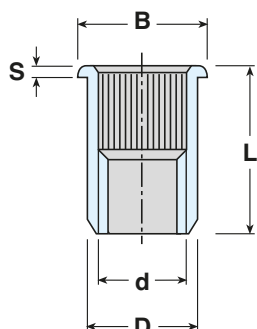

d 6H	D mm	B mm	S mm	mm	mm	L ₁ mm	L mm	Cod. Art. Item code		€ per 1.000		€ per 1.000
M3	4,9	6	0,8	5	0,3÷1,0	5,5÷5,8	8,5	33M3 TPZ-C	200	132,20	2.500	110,00
M4	5,9	8	1	6	0,3÷2,5 2,5÷4,0	5,9÷6,4	11 13	33M4 TPZ-C 33M4 TPZ-L	200	165,00 178,00	2.500	138,00 146,00
M5	6,9	9	1,2	7	0,5÷3,0 3,0÷5,0	7,3÷7,8	13 15,5	33M5 TPZ-C 33M5 TPZ-L	200	230,40 240,00	2.500	194,00 200,00
M6	8,9	11	1,5	9	0,5÷3,5 3,5÷5,0	8,3÷8,8	15,5 17,5	33M6 TPZ-C 33M6 TPZ-L	200	382,00 394,00	2.500	320,00 330,00
M8	10,9	14,5	1,5	11	0,8÷3,5 3,5÷6,0	10,5÷11,2	17,5 20	33M8 TPZ-C 33M8 TPZ-L	200	566,00 633,00	2.500	472,00 528,00
M10	12,9	17	1,7	13	1,0÷3,5 3,5÷6,0	13÷14	21 24	33M10 TPZ-C13 33M10 TPZ-L13	200	729,60 828,00	1.000	608,00 690,00

* A richiesta disponibil anche ciechi.

* Available on request also closed end.

d		
	Trazione (N)	Coppia max serraggio (Nm)
	Inox	Inox
M3	3.600	1,2
M4	5.800	6,0
M5	11.000	12,5
M6	21.800	20,5
M8	30.500	30,0
M10	37.800	51,0





INSERTI FILETTATI ZIGRINATI A TESTA SVASATA IN ACCIAIO INOX

KNURLED THREADED INSERTS COUNTERSUNK HEAD STAINLESS STEEL

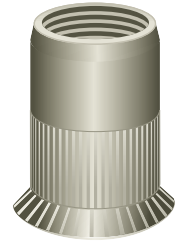
BLIND-EINNIETMUTTERN-SENKKOPF AUS EDELSTAHL

Acciaio inox AISI 304 Cu
Stainless steel AISI 304 Cu
Edelstahl AISI 304 Cu



d 6H	D mm	B mm	S mm	 mm	 mm	L ₁ mm	L mm	Cod. Art. Item code		€ per 1.000		€ per 1.000
M4	5,9	8	1,5	6	1,5÷3,5 3,5÷5,0	5,9÷6,4	11 13	33M4 TSZ-C 33M4 TSZ-L	200	165,00 178,00	2.500	138,00 146,00
M5	6,9	9	1,5	7	1,5÷3,8 3,8÷5,0	7,5÷8,0	13 15	33M5 TSZ-C 33M5 TSZ-L	200	230,40 240,00	2.500	194,00 200,00
M6	8,9	11	1,5	9	1,5÷3,8 3,8÷5,0	8,0÷8,5	15 17	33M6 TSZ-C 33M6 TSZ-L	200	382,00 394,00	2.500	320,00 330,00
M8	10,9	13,5	1,5	11	1,5÷3,8 3,8÷6,0	10,5÷11,2	18 19	33M8 TSZ-C 33M8 TSZ-L	200	566,00 633,00	2.500	472,00 528,00
M10	12,9	15	1,5	13	1,5÷3,5 3,5÷6,0	11,6÷12,2	18 21	33M10 TSZ-C 33M10 TSZ-L	200	729,60 828,00	2.000	608,00 690,00

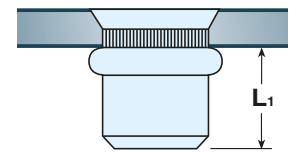
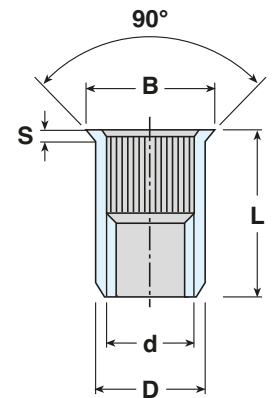

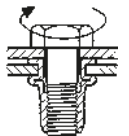
d		
	Trazione (N)	Coppia max serraggio (Nm)
	Inox	Inox
M4	5.800	6,0
M5	11.000	12,5
M6	21.800	20,5
M8	30.500	30,0
M10	37.800	51,0

INSERTI FILETTATI ZIGRINATI A TESTA RIDOTTA IN ACCIAIO INOX
KNURLED THREADED INSERTS REDUCED HEAD IN STAINLESS STEEL
BLIND-EINNIETMUTTERN-FLACHKOPF AUS EDELSTAHL



Acciaio inox AISI 304 Cu
 Stainless steel AISI 304 Cu
 Edelstahl AISI 304 Cu

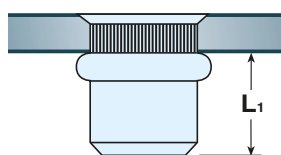
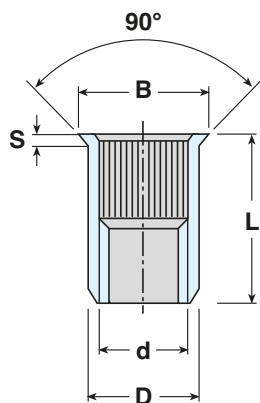

d 6H	D mm	B mm	S mm	mm	mm	L ₁ mm	L mm	Cod. Art. Item code		€ per 1.000		€ per 1.000
M4	5,9	6,75	0,50	6	0,5÷1,5 1,5÷3,5	6,4÷6,9	10 12	33M4 TSRZ 33M4 TSRZL	200	142,00 153,00	2.500	118,00 130,00
M5	6,9	8	0,60	7	0,5÷2,0 2,0÷4,0	8,0÷8,5	12 13,5	33M5 TSRZ 33M5 TSRZL	200	220,00 242,00	2.500	185,00 203,50
M6	8,9	10	0,60	9	0,5÷2,5 2,5÷5,0	9,0÷9,7	13,5 16	33M6 TSRZ 33M6 TSRZL	200	354,00 388,00	2.500	296,00 326,00
M8	10,9	12	0,60	11	1,0÷3,0 3,0÷6,0	10÷11,4	16 19	33M8 TSRZ 33M8 TSRZL	200	498,00 546,00	2.500	416,00 452,00
M10	12,9	14,5	0,80	13	1,0÷3,5 3,5÷6,0	12,5÷13,0	20 23	33M10 TSRZ 13 33M10 TSRZL 13	200	625,00 637,00	1.000	522,00 574,00

d		
	Trazione (N)	Coppia max serraggio (Nm)
	Inox	Inox
M4	5.800	6,0
M5	11.000	12,5
M6	21.800	20,5
M8	30.500	30,0
M10	38.000	50,0

INSERTI FILETTATI ESAGONALI A TESTA RIDOTTA IN ACCIAIO INOX
THREADED INSERTS REDUCED HEAD HEXAGONAL SHANK STAINLESS STEEL
BLIND-EINNIETMUTTERN-KLEINKOPF-SECHSKANT AUS EDELSTAHL

Acciaio inox AISI 304 Cu
 Stainless steel AISI 304 Cu
 Edelstahl AISI 304 Cu

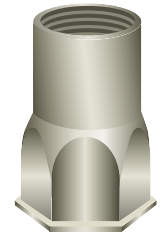

d 6H	M mm	B mm	S mm	M ₁ mm		L ₁ mm	L mm	Cod. Art. Item code		€ per 1.000		€ per 1.000
M4	5,9	6,6	0,5	6	0,5÷2,0 2,0÷3,0	5,5÷6,0	12 13	33M4 TRE 33M4 TREL	200	160,00 176,00	2.500	134,00 146,00
M5	6,9	8	0,6	7	0,5÷2,5 2,5÷4,0	7,6÷8,3	13 14,5	33M5 TRE 33M5 TREL	200	254,00 279,00	2.500	212,20 233,40
M6	8,9	10	0,6	9	0,7÷3,0 5,0÷5,5	10,3÷10,7	16 18	33M6 TRE 33M6 TREL	200	404,00 445,00	2.500	338,00 372,00
M8	10,9	12	0,6	11	0,9÷3,3 3,0÷5,0	11,8÷12,5	17 20	33M8 TRE 33M8 TREL	200	572,00 628,00	2.500	478,00 526,00
M10	12,9	14	0,8	13	1,0÷4,0 4,0÷6,0	16÷16,5	21 23	33M10 TRE 13 33M10 TREL13	200	680,00 748,00	1.000	566,00 622,00

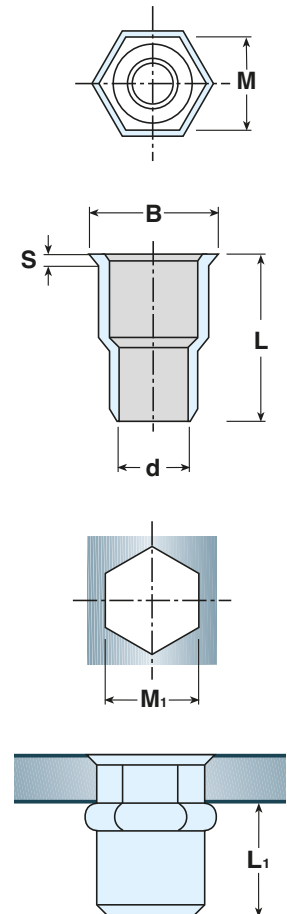



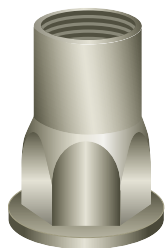

d		
	Trazione (N)	Coppia max serraggio (Nm)
	Acciaio	Acciaio
M4	5.800	6,0
M5	11.000	12,5
M6	21.800	20,5
M8	30.500	30,0
M10	32.000	48,0

INSERTI FILETTATI ESAGONALI A TESTA CILINDRICA IN ACCIAIO INOX
THREADED INSERTS CYLINDRICAL HEAD HEXAGONAL STAINLESS STEEL
BLIND-EINNIETMUTTERN-FLACHKOPF-SECHSKANT AUS EDELSTAHL

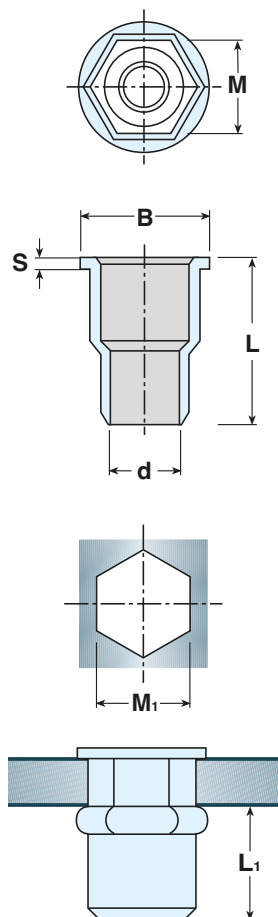

Acciaio inox AISI 304 Cu
 Stainless steel AISI 304 Cu
 Edelstahl AISI 304 Cu

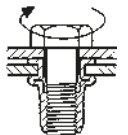

d 6H	M mm	B mm	S mm	M ₁ mm	 mm	L ₁ mm	L mm	Cod. Art. Item code		€ per 1.000		€ per 1.000
M4	5,9	9	0,8	6	0,5÷2,0	6,5÷7,5	11	33M4 TPEP	200	184,00	2.500	160,00
M5	6,9	10	1	7	0,5÷3,0	7,6÷8,3	12	33M5 TPEP	200	264,00	2.500	220,00
M6	8,9	13	1,5	9	0,7÷3,0	10,3÷10,7	15	33M6 TPEP	200	452,00	2.500	378,00
M8	10,9	16	1,5	11	0,5÷3,5	11,8÷12,5	19	33M8 TPEP	200	696,00	2.500	582,00
M10	12,9	17	1,7	13	1,0÷3,5	12÷13	21	33M10 TPEP	200	824,00	1.000	680,00

d		
	Trazione (N) Inox	Coppia max serraggio (Nm) Inox
M4	5.200	7,0
M5	11.000	12,5
M6	21.800	20,5
M8	30.500	30,0
M10	36.000	48,0

INSERTI FILETTATI IN ACCIAIO INOX (A2) A TESTA RIDOTTA GAMBO PARZIALMENTE ESAGONALE CIECO
STAINLESS STEEL (A2) BLIND RIVET NUTS REDUCED HEAD - HALF HEXAGONAL SHANK - CLOSED END TYPE
EDELSTAHL (A2) BLINDNIETMUTTERN - KLEINKOPF - TEILSECHSKANTSCHAFT GESCHLOSSEN

Acciaio inox AISI 304 Cu
 Stainless steel AISI 304 Cu
 Edelstahl AISI 304 Cu

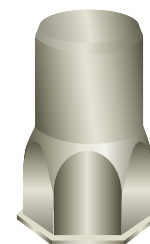

d 6H	M mm	B mm	S mm	M ₁ mm		L ₁ mm	L mm	Cod. Art. Item code		€ per 1.000		€ per 1.000
M4	5,9	6,6	0,5	6	0,5÷2,0 2,0÷4,0	11,5	15,5 17,5	33M4 TREC 33M4 TRECL	200		2.500	
M5	6,9	8	0,6	7	0,5÷2,5 2,0÷4,0	13,5	18 20	33M5 TREC 33M5 TRECL	200		2.500	
M6	8,9	10	0,6	9	0,7÷3,0 3,0÷5,0	16,0	21,5 23	33M6 TREC 33M6 TRECL	200		2.500	
M8	10,9	12	0,6	11	0,9÷3,5 3,0÷5,0	18,0	24 26	33M8 TREC 32M8 TRECL	200		2.500	
M10	12,9	14	0,8	13	1,0÷4,0 4,0÷6,0	23,0	30,5 33	33M10 TREC 13 33M10 TRECL 13	200		1.000	

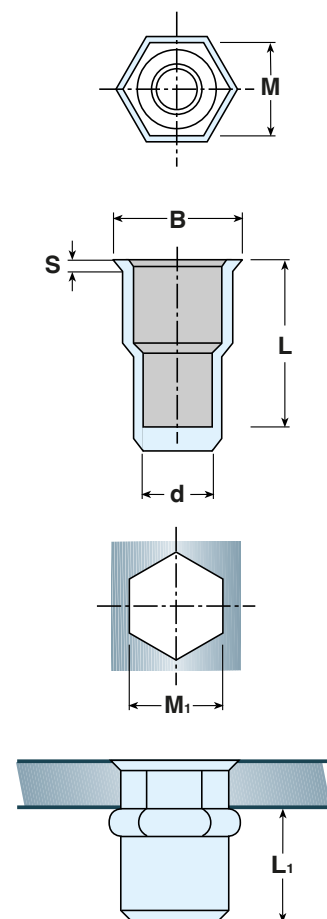



d		
	Trazione (N)	Coppia max serraggio (Nm)
	Acciaio	Acciaio
M4	5.800	6,0
M5	11.000	12,5
M6	21.800	20,5
M8	30.500	30,0
M10	32.000	48,0

INSERTI FILETTATI ESAGONALI A TESTA CILINDRICA IN ACCIAIO
STEEL THREADED HEXAGONAL INSERTS CYLINDRICAL HEAD
BLIND-EINNIETMUTTERN-FLACHKOPF-SECHSKANT AUS STAHL

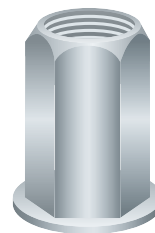
Acciaio Zincato C4C
 Zinc plated steel C4C
 Stahl Verzinkt C4C



d 6H	M mm	B mm	S mm	M ₁ mm	 mm	L ₁ mm	L mm	Cod. Art. Item code		€ per 1.000		€ per 1.000
M4	5,9	9	1	6	0,5÷2,0	5,0÷5,5	11	32M4 TPE	200	101,00	2.500	80,90
M5	6,9	10	1	7	0,5÷3,0	7,2÷7,7	14	32M5 TPE	200	112,80	2.500	90,40
M6	8,9	13	1,5	9	0,5÷3,0	9,3÷9,7	15	32M6 TPE	200	140,00	2.500	112,20
M8	10,9	16	1,5	11	0,5÷3,0	10,8÷11,5	18	32M8 TPE	200	173,80	2.500	146,80
M10	11,9	18	1,7	12	0,5÷3,0	12,8÷13,5	20	32M10 TPE	200	205,00	2.000	163,90
M10	12,9	19	2,0	13	1,0÷3,5	13,0÷13,5	23	32M10 TPE13	200	232,00	1.000	185,20
M12	15,9	20	2,0	16	1,0÷4,0	17-18	23	32M12 TPE16	200	488,00	1.000	442,00

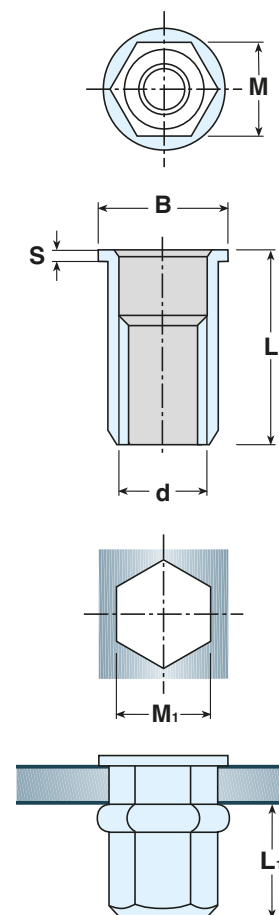

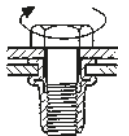

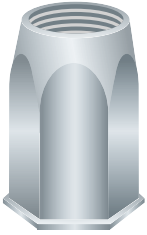

d		
	Trazione (N)	Coppia max serraggio (Nm)
	Acciaio	Acciaio
M4	6.000	3,8
M5	10.000	6,0
M6	15.000	11,5
M8	22.500	22,0
M10	26.000	37,0
M12	42.000	66,0

INSERTI FILETTATI ESAGONALI A TESTA RIDOTTA IN ACCIAIO
STEEL THREADED INSERTS REDUCED HEAD HEXAGONAL SHANK
BLIND-EINNIETMUTTERN-KLEINKOPF-SECHSKANT AUS STAHL

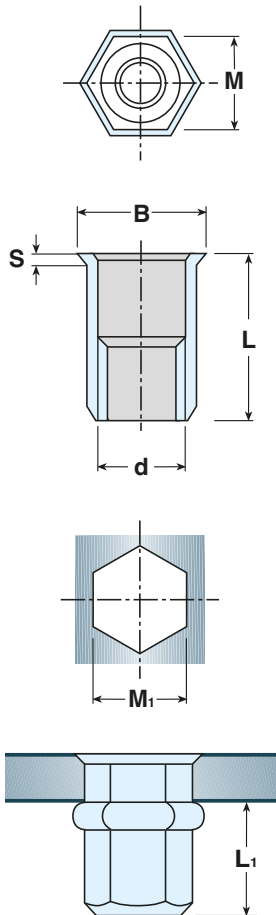

Acciaio Zincato C4C
 Zinc plated steel C4C
 Stahl Verzinkt C4C

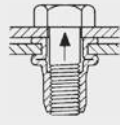
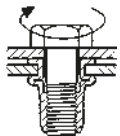

d 6H	M mm	B mm	S mm	M ₁ mm	 mm	L ₁ mm	L mm	Cod. Art. Item code		€ per 1.000		€ per 1.000
M4	5,9	6,6	0,5	6	0,5÷2,0	5,5÷6,0	11	32M4 TRE	200	97,00	2.500	75,40
M5	6,9	8	0,6	7	0,5÷3,0 3,0÷5,0	7,6÷8,3	14 16	32M5 TRE 32M5 TRE-L	200	108,40	2.500	84,20
M6	8,9	10	0,6	9	0,5÷3,5 3,5÷6,0	10,3÷10,7	16 18	32M6 TRE 32M6 TRE-L	200	130,80	2.500	104,00
M8	10,9	12	0,8	11	0,5÷3,5 3,5÷6,0	11,8÷12,5	18 20	32M8 TRE 32M8 TRE-L	200	154,00	2.500	123,30
M10	11,9	13,5	0,8	12	1÷3,5	16,3÷16,8	21	32M10 TRE	200	160,00	2.000	130,00
M10	12,9	14,5	0,8	13	1÷3,5 4÷7,5	16÷16,5	21 24	32M10 TRE13 32M10 TRE13-L	200	165,00	1.000	132,00
M12	15,9	17,8	1,0	16	1-4,0	16,5-17	25	32M12 TRE16	200	490,00	800	448,00

d		
	Trazione (N)	Coppia max serraggio (Nm)
	Acciaio	Acciaio
M4	6.000	3,8
M5	10.000	6,0
M6	15.000	11,5
M8	22.500	22,0
M10	26.000	37,0
M12	42.000	66,0

INSERTI FILETTATI ESAGONALI A TESTA RIDOTTA IN ACCIAIO
THREADED INSERTS REDUCED HEAD HEXAGONAL SHANK STEEL
BLIND-EINNIETMUTTERN-KLEINKOPF-SECHSKANT AUS STAHL

Acciaio Zincato C4C
 Zinc plated steel C4C
 Stahl Verzinkt C4C

*Differiscono dal modello TRE nella dimensione esagonale
 *Different from TRE in the outside hexagonal dimension

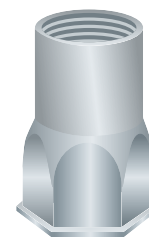

d 6H	M mm	B mm	S mm	M ₁ mm		L ₁ mm	L mm	Cod. Art. Item code		€ per 1.000		€ per 1.000
M4	6,3	7,3	0,5	6,4	0,5÷2,0	6,5÷7,0	10,5	32M4 TREP	200	105,00	2.500	95,60
M5	7,2	8	0,5	7,3	0,5÷3,0	6,5÷7,0	12	32M5 TREP	200	117,00	2.500	106,80
M6	9,6	10,6	0,5	9,7	0,7÷3,0	9,5÷9,8	14,6	32M6 TREP	200	128,60	2.500	109,40
M8	10,6	11,6	0,5	10,7	0,9÷3,3	10,2÷10,6	16	32M8 TREP	200	172,00	2.500	155,60

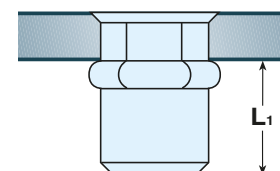
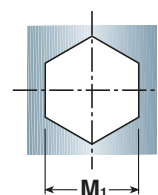
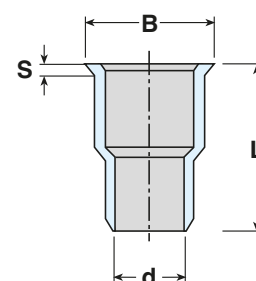
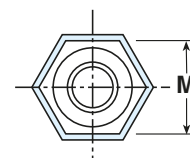

d		
	Trazione (N) Acciaio	Coppia max serraggio (Nm) Acciaio
M4	6.000	3,8
M5	8.000	6,0
M6	11.200	11,5
M8	12.000	22,0

INSERTI FILETTATI ESAGONALI CIECHI A TESTA RIDOTTA

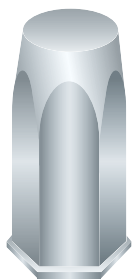

STEEL THREADED BLIND INSERTS REDUCED HEAD

BLIND KLEINKOPF-GEWINDEBUCHSEN AUS STAHL

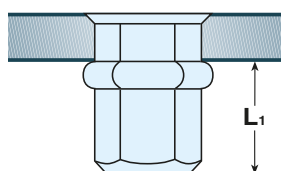
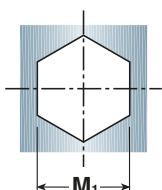
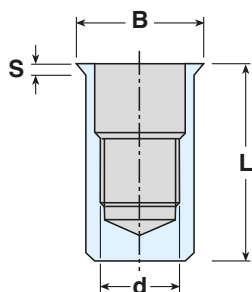
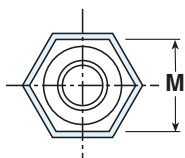

Acciaio Zincato C4C
Zinc plated steel C4C
Stahl Verzinkt C4C

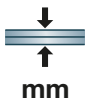

d mm	M mm	B mm	S mm	M ₁ mm	 mm	L ₁ mm	L mm	Cod. Art. Item code		€ per 1.000		€ per 1.000
M4	5,9	6,6	0,5	6	0,5÷2,0	11,2÷11,7	16	32M4 TREC	200	136,40	2.500	129,00
M5	6,9	8	0,6	7	0,5÷3,0	14,0÷14,9	20	32M5 TREC	200	151,80	2.500	138,00
M6	8,9	10	0,6	9	0,5÷3,0	16,3÷16,7	22	32M6 TREC	200	196,50	2.500	166,50
M8	10,9	12	0,8	11	0,5÷3,0	19÷19,7	26	32M8 TREC	200	277,00	2.000	245,00
M10	12,9	13	0,8	13	1÷3,5	20÷21	28,5	32M10TREC13	200	332,00	1.000	294,00

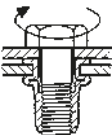
d		
	Trazione (N)	Coppia max serraggio (Nm)
	Acciaio	Acciaio
M4	6.300	3,8
M5	10.000	6,0
M6	15.000	11,5
M8	24.500	22,0
M10	26.000	37,0

INSERTI FILETTATI ESAGONALI CIECHI A TESTA CILINDRICA IN ACCIAIO

STEEL THREADED BLIND INSERTS CYLINDRICAL HEAD - CLOSED END

BLIND ZYLINDERKOPF-GEWINDEBUCHSEN AUS STAHL

Acciaio Zincato C4C
Zinc plated steel C4C
Stahl Verzinkt C4C

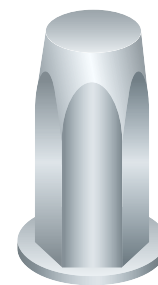

d mm	M mm	B mm	S mm	M ₁ mm		L ₁ mm	L mm	Cod. Art. Item code		€ per 1.000		€ per 1.000
M4	5,9	9	1	6	0,5÷2,0	10÷10,5	16	32M4 TPEC	200	158,00	2.500	135,20
M5	6,9	10	1	7	0,5÷3,0	13,2÷13,7	20	32M5 TPEC	200	173,20	2.500	146,80
M6	8,9	13	1,5	9	0,5÷3,0	16,3÷16,7	22	32M6 TPEC	200	209,60	2.500	177,60
M8	10,9	16	1,5	11	0,5÷3,0	18,8÷19,5	26	32M8 TPEC	200	286,20	2.000	251,50

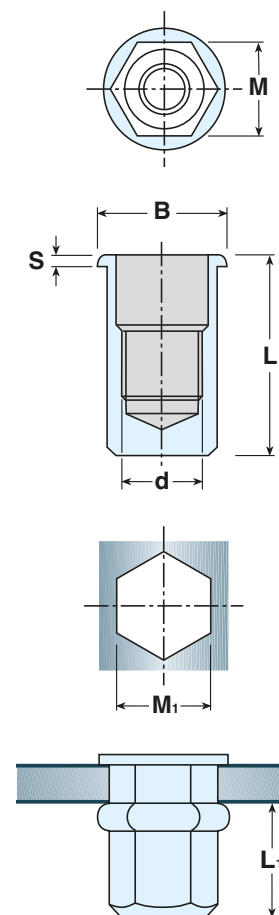

d		
	Trazione (N)	Coppia max serraggio (Nm)
	Acciaio	Acciaio
M4	6.300	4,50
M5	10.000	8,00
M6	15.000	14,00
M8	24.500	22,00

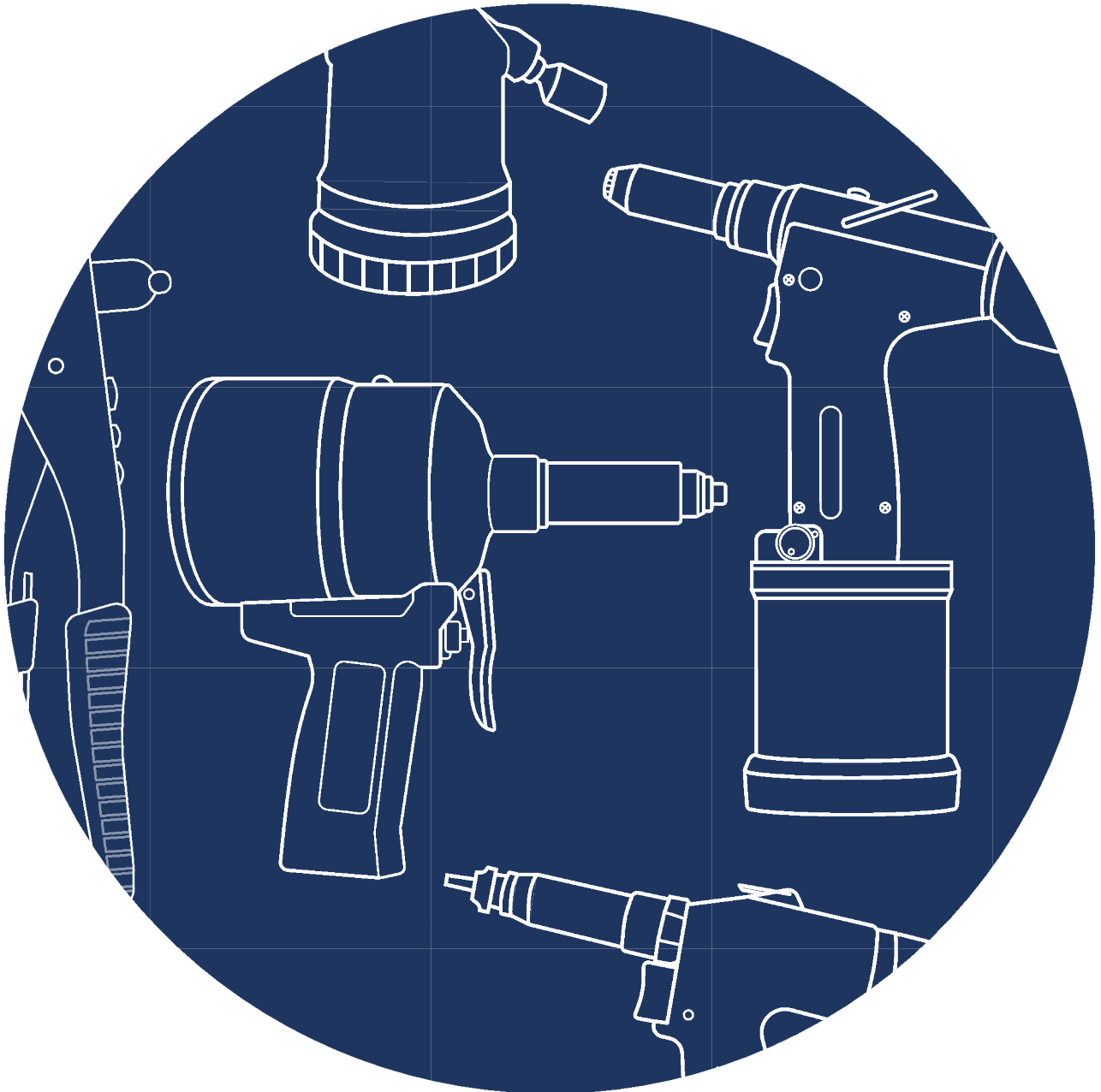

RIVETTATRICI

RIVETING TOOLS

HANDNIETZANGE



Articolo **DX2** € **17,00**

PESO - WEIGHT - GEWICHT	kg 0,550
LUNGHEZZA - LENGHT - GESAMTLANGE	mm 260 x 76

RIVETTI BLIND RIVETS BLINDNIETEN	ALLUMINIO ALUMINIUM ALUMINIUM	ACCIAIO STEEL STAHL	RAME COPPER KUPFER	INOX INOX INOX
2,4	•			
3,0 - 3,2	•	•	•	•
4,0	•	•	•	•
4,8	•			



Articolo **DX4** € **24,00**

PESO - WEIGHT - GEWICHT	kg 0,520
LUNGHEZZA - LENGHT - GESAMTLANGE	mm 260 x 75

RIVETTI BLIND RIVETS BLINDNIETEN	ALLUMINIO ALUMINIUM ALUMINIUM	ACCIAIO STEEL STAHL	RAME COPPER KUPFER	INOX INOX INOX
2,4	•			
3,0 - 3,2	•	•	•	•
4,0	•	•	•	•
4,8	•			



Articolo **DX5** € **32,20**

PESO - WEIGHT - GEWICHT	kg 0,540
LUNGHEZZA - LENGHT - GESAMTLANGE	mm 250 x 76

RIVETTI BLIND RIVETS BLINDNIETEN	ALLUMINIO ALUMINIUM ALUMINIUM	ACCIAIO STEEL STAHL	RAME COPPER KUPFER	INOX INOX INOX
2,4	•			
3,0 - 3,2	•	•	•	•
4,0	•	•	•	•
4,8	•			



Articolo **DX5 SM** € **32,20**

SENZA MOLLA DI RITORNO

PESO - WEIGHT - GEWICHT	kg 0,500
LUNGHEZZA - LENGHT - GESAMTLANGE	mm 250 x 76

RIVETTI BLIND RIVETS BLINDNIETEN	ALLUMINIO ALUMINIUM ALUMINIUM	ACCIAIO STEEL STAHL	RAME COPPER KUPFER	INOX INOX INOX
2,4	•			
3,0 - 3,2	•	•	•	•
4,0	•	•	•	•
4,8	•			

Articolo €
SUPER 5 53,00

PESO - WEIGHT - GEWICHT	kg 0,800
LUNGHEZZA - LENGHT - GESAMTLANGE	mm 280 x 90

RIVETTI BLIND RIVETS BLINDNIETEN	ALLUMINIO ALUMINIUM ALUMINIUM	ACCIAIO STEEL STAHL	RAME COPPER KUPFER	INOX INOX INOX
3,0 - 3,2	•	•	•	•
4,0	•	•	•	•
4,8	•	•	•	•



Articolo €
DX65 75,00

PESO - WEIGHT - GEWICHT	kg 1,90
LUNGHEZZA - LENGHT - GESAMTLANGE	mm 530

RIVETTI BLIND RIVETS BLINDNIETEN	ALLUMINIO ALUMINIUM ALUMINIUM	ACCIAIO STEEL STAHL	RAME COPPER KUPFER	INOX INOX INOX
3,0 - 3,2	•	•	•	•
4,0	•	•	•	•
4,8	•	•	•	•
6,0	•	•	•	•
6,4	•	•	•	•
7,8	•	•	•	•



Disponibile anche per rivetti Unibolt e Tribol
a partire dal diametro 4,8

DX65MB
€ 110,00

Articolo €
DX8 130,00

PESO - WEIGHT - GEWICHT	kg 1,90
LUNGHEZZA - LENGHT - GESAMTLANGE	mm 320+850

RIVETTI BLIND RIVETS BLINDNIETEN	ALLUMINIO ALUMINIUM ALUMINIUM	ACCIAIO STEEL STAHL	RAME COPPER KUPFER	INOX INOX INOX
3,0 - 3,2	•	•	•	•
4,0	•	•	•	•
4,8	•	•	•	•
6,0	•	•	•	•
6,4	•	•	•	•

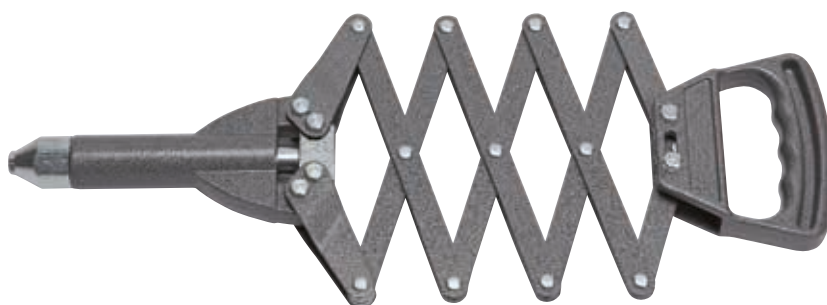

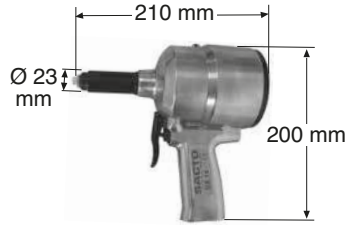

Articolo
DX14 €
228,00

Rivettatrice pneumatica
Pneumatic tool
Pneumatisches Werkzeug

PESO - WEIGHT - GEWICHT				kg 1,3
Ø	ALLUMINIO ALUMINIUM ALUMINIUM	RAME COPPER KUPFER	ACCIAIO STEEL STAHL	INOX INOX INOX
2,4	•			
3	•	•	•	•
3,2	•	•	•	•
4	•	•	•	•
4,8	•			



Articolo
DX14 AS €
289,00

Rivettatrice pneumatica con trattenuta del rivetto e recupero chiodo
Pneumatic tool with nail recovery
Pneumatisches Werkzeug mit Nietdorn Auffangbehälter

PESO - WEIGHT - GEWICHT				kg 1,5
Ø	ALLUMINIO ALUMINIUM ALUMINIUM	RAME COPPER KUPFER	ACCIAIO STEEL STAHL	INOX INOX INOX
2,4	•			
3	•	•	•	•
3,2	•	•	•	•
4	•	•	•	•
4,8	•			

Articolo €
DX16 462,00

Rivettatrice oleopneumatica con trattenuta del rivetto e recupero del chiodo tranciato

Hydropneumatic tool with holding of the rivet and nail recovery

Ölpneumatisches Werkzeug mit Nietdorn-Absaugvorrichtung und Auffangbehälter

PESO - WEIGHT - GEWICHT		kg 1,30			
Ø	ALLUMINIO ALUMINIUM ALUMINIUM	RAME COPPER KUPFER	ACCIAIO STEEL STAHL	INOX INOX INOX	
2,4	•				
3	•				
3,2	•	•	•	•	•
4	•	•	•	•	•
4,8/5	•				



Articolo €
DX20 560,00

Rivettatrice oleopneumatica con trattenuta del rivetto e recupero del chiodo tranciato

Hydropneumatic tool with holding of the rivet and nail recovery

Ölpneumatisches Werkzeug mit Nietdorn-Absaugvorrichtung und Auffangbehälter

PESO - WEIGHT - GEWICHT		kg 1,50			
Ø	ALLUMINIO ALUMINIUM ALUMINIUM	RAME COPPER KUPFER	ACCIAIO STEEL STAHL	INOX INOX INOX	
2,4	•				
3	•		•	•	•
3,2	•	•	•	•	•
4	•	•	•	•	•
4,8/5	•	•	•	•	•



Articolo €
DX30 790,00

Rivettatrice oleopneumatica con trattenuta del rivetto e recupero del chiodo tranciato per rivetti a strappo e rivetti **strutturali unibolt**

Hydropneumatic tool with holding of the rivet and nail recovery for blind rivets and structural **rivets unibolt**

Ölpneumatisches Werkzeug mit Nietdorn-Absaugvorrichtung und Auffangbehälter für Blindniete und structurelle **Blindniete unibolt**

PESO - WEIGHT - GEWICHT		kg 1,75			
Ø	ALLUMINIO ALUMINIUM ALUMINIUM	UNIBOLT MAGNA- LOCK	ACCIAIO STEEL STAHL	INOX INOX INOX	
4	•		•	•	•
4,8/5	•	•	•	•	•
6	•		•	•	•
6,4	•	•	•	•	•
7,8	•				





Articolo €
DX45BAT 1.160,00

Rivettatrice elettrica in valigetta completa di un carica-batteria e **due batterie al litio** (18 V / 2,0 Ah)

Case containing one tool, one battery charger and **two lithium battery**

Kunststoffkoffer mit 1 Nietgerät, 1 Ladegerät und **2 Lithium Batterien**

PESO - WEIGHT - GEWICHT				kg 1,90
Ø	ALLUMINIO ALUMINIUM ALUMINIUM	RAME COPPER KUPFER	ACCIAIO STEEL STAHL	INOX INOX INOX
3	•	•	•	•
3,2	•	•	•	•
4	•	•	•	•
4,8/5	•	•	•	•



Articolo €
DX75BAT 1.260,00

Rivettatrice elettrica in valigetta completa di un carica-batteria e **due batterie al litio** (18 V / 2,0 Ah)

Case containing one tool, one battery charger and **two lithium battery**

PESO - WEIGHT - GEWICHT				kg 1,90
Ø	ALLUMINIO ALUMINIUM ALUMINIUM	RAME COPPER KUPFER	ACCIAIO STEEL STAHL	INOX INOX INOX
4	•	•	•	•
4,8-5	•	•	•	•
6,4	•	•	•	•
7,8	•			
Rivetti strutturali / Structural rivets				

Accessori a richiesta / Accessories on demand

Ugello per rivetto unibolt 4,8 mm cod. 160000004MB
Ugello per rivetto unibolt 6,4 mm cod. 160000005MB
Kit per rivetto tribol 7,8 mm cod. KIT16005TR



Articolo €
NX90BAT 1.880,00

Rivettatrice elettrica per inserti filettati in valigetta completa di un caricabatteria e **due batterie al litio** (18 V / 2,0 Ah)

Case containing one tool, one battery charger and **two lithium battery**

PESO - WEIGHT - GEWICHT				kg 2,30
RIVETTI BLIND RIVETS BLINDNIETEN	ALLUMINIO ALUMINIUM ALUMINIUM	ACCIAIO STEEL STAHL	INOX INOX INOX	
M4	•	•	•	
M5	•	•	•	
M6	•	•	•	
M8	•	•	•	
M10	•	•		NO

Articolo
NX5 €
48,30

Rivettatrice per inserti filettati con tiranti da M3-M4-M5

Tool for threaded inserts M3-M4-M5

Handwerkzeug für Blindnietmuttern M3-M4-M5

PESO - WEIGHT - GEWICHT	kg 0,560
LUNGHEZZA - LENGHT - GESAMTLANGE	mm 250

RIVETTI BLIND RIVETS BLINDNIETEN	ALLUMINIO ALUMINIUM ALUMINIUM	ACCIAIO STEEL STAHL	INOX INOX INOX
M3	•	•	•
M4	•	•	•
M5	•	•	•



Articolo
NX55 €
102,00

Rivettatrice per inserti filettati con tiranti da M3-M4-M5-M6

Tool for threaded inserts M3-M4-M5-M6

Handwerkzeug für Blindnietmuttern M3-M4-M5-M6

PESO - WEIGHT - GEWICHT	kg 0,910
LUNGHEZZA - LENGHT - GESAMTLANGE	mm 340 x 90

RIVETTI BLIND RIVETS BLINDNIETEN	ALLUMINIO ALUMINIUM ALUMINIUM	ACCIAIO STEEL STAHL	INOX INOX INOX
M3	•	•	•
M4	•	•	•
M5	•	•	•
M6	•	•	•



Articolo
CPNX5 €
79,00

Confezione in cassetta di plastica contenente una rivettatrice NX5 con tiranti M3-M4-M5

PESO - WEIGHT - GEWICHT	kg 0,910
DIMENSIONI - SIZE - DIMENSION	mm 300x140x50





Articolo NX65 CNX65	€	Scatola di cartone Carton box
	202,00	Cassetta di metallo Metal case
	248,00	

Rivettatrice per inserti filettati M3-M4-M5-M6-M8-M10
 Tool for threaded inserts M3-M4-M5-M6-M8-M10
 Handwerkzeug für Blindnietmuttern M3-M4-M5-M6-M8-M10

PESO - WEIGHT - GEWICHT	kg 2,20 / 4,50
DIMENSIONI - SIZE - DIMENSION	mm 550x200x60

RIVETTI BLIND RIVETS BLINDNIETEN	ALLUMINIO ALUMINIUM ALUMINIUM	ACCIAIO STEEL STAHL	INOX INOX INOX
M3	•	•	•
M4	•	•	•
M5	•	•	•
M6	•	•	•
M8	•	•	•
M10	•	•	•



Articolo NX70 CNX70	€	Scatola di cartone Carton box
	127,00	Cassetta di metallo Metal case
	177,00	

Rivettatrice per inserti filettati M6-M8-M10-M12
 Tool for threaded inserts M6-M8-M10-M12
 Handwerkzeug für Blindnietmuttern M6-M8-M10-M12

PESO - WEIGHT - GEWICHT	kg 2,20 / 4,50
DIMENSIONI - SIZE - DIMENSION	mm 550x200x60

RIVETTI BLIND RIVETS BLINDNIETEN	ALLUMINIO ALUMINIUM ALUMINIUM	ACCIAIO STEEL STAHL	INOX INOX INOX
M6	•	•	•
M8	•	•	•
M10	•	•	•
M12	•	•	•

Articolo
NX36 €
1.680,00

Rivettatrice oleopneumatica per inserti filettati M3-M10.
Hydropneumatic tool for threaded inserts M3-M10.
Öl-pneumatisches Werkzeug für Blindnietmuttern M3-M10.

PESO - WEIGHT - GEWICHT				kg 2,2
M	ALLUMINIO ALUMINIUM ALUMINIUM	ACCIAIO STEEL STAHL	INOX INOX INOX	
M3	•	•	•	
M4	•	•	•	
M5	•	•	•	
M6	•	•	•	
M8	•	•	•	
M10	•	•	•	



Articolo
NX41 €
1.940,00

Rivettatrice oleopneumatica per inserti filettati M6-M12.
Hydropneumatic tool for threaded inserts M6-M12.
Öl-pneumatisches Werkzeug für Blindnietmuttern M6-M12.

PESO - WEIGHT - GEWICHT				kg 2,5
M	ALLUMINIO ALUMINIUM ALUMINIUM	ACCIAIO STEEL STAHL	INOX INOX INOX	
M6	•	•	•	
M8	•	•	•	
M10	•	•	•	
M12	•	•	•	



Accessori a richiesta / Accessories on demand
Kit tirante per inserti maschi per NX36 e NX41
Tie-rod and head for blind rivet bolts for NX36 and NX41



Articolo	€
CNX55	188,50

Confezione in cassetta di metallo contenente una rivettrici CNX55 con tiranti M3-M4-M5-M6 completi di testine e 400 inserti filettati assortiti.

Metal box containing a riveting tool CNX55 with mandrels and heads M3-M4-M5-M6, with threaded inserts

Metalkassette mit werkzeug CNX55, ziehdorne und köpfe M3-M4-M5-M6, sowie Blindnietmuttern

PESO - WEIGHT - GEWICHT	kg 3,500
DIMENSIONI - SIZE - DIMENSION	mm 360x240x60

RIVETTI BLIND RIVETS BLINDNIETEN	ALLUMINIO ALUMINIUM	ACCIAIO STEEL STAHL	INOX INOX INOX
M3	•	•	•
M4	•	•	•
M5	•	•	•
M6	•	•	•



Articolo	€
SDX2	30,00
SDX4	38,00
SDX5	45,00

PESO - WEIGHT - GEWICHT	kg 0,930
DIMENSIONI - SIZE - DIMENSION	mm 300x140x50

Confezione contenente una rivettrici tra quelle specificate in tabella con rivetti di alluminio assortiti dal diametro 3 al 4,8.

Box containing a riveting tool, on those show in the table below, with aluminium 3 to 4,8 Ø rivets.

Die plastikkasten enthält ein obengennantes Blindnietgerät, mit Blindnietesortiment Durchmesser 3-4, 8 aus Stahl/Aluminium Flachrundkopf.



Articolo	€
C-DX2	53,00
C-DX4	62,00
C-DX5	67,00
C-SUPER 5	96,00

PESO - WEIGHT - GEWICHT	kg 2,900
DIMENSIONI - SIZE - DIMENSION	mm 300x240x60

Confezione contenente una rivettrici tra quelle specificate in tabella con rivetti di alluminio assortiti dal diametro 3 al 4,8.

Box containing a riveting tool, on those show in the table below, with aluminium 3 to 4,8 Ø rivets.

Die Stahlblechkasten enthält ein obengennantes Blindnietgerät, mit Blindnietesortiment Durchmesser 3-4, 8 aus Stahl/Aluminium Flachrundkopf.

UGELLI PROLUNGATI

EXTENDED NOSEPIECE

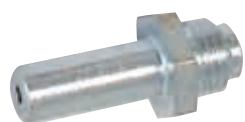

Gli ugelli prolungati devono essere utilizzati con rivetti con il gambo lungo.

To use only with rivets with long nail.

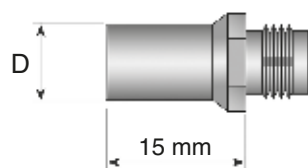
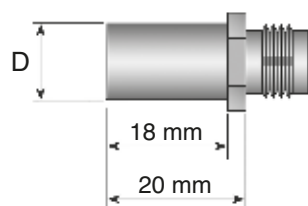

Per rivettatrici DX16 - DX20 - DX30

Cod. / Code	D	Per rivetto / For rivets Ø	€ / Cad.
10787L20	7	2,4 - 3,2	15,00
10788L20	7	3,4 - 4,0	15,00
10701L20	8	5,0	15,00
10987L20	9	6,0 - 7,8	15,00

Per rivettatrici DX14 - DX14AS

Cod. / Code	D	Per rivetto / For rivets Ø	€ / Cad.
10413L12	6,3	2,4 - 3,2	14,00
10414L12	8	3,4 - 4,0	14,00
10416L12	9	5,0	14,00

TESTE PROLUNGATE

EXTENDED HEADS

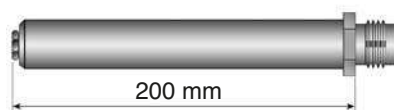
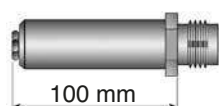

Cod. / Code	Ø	Per rivettatrici / for tools	€ / Cad.
10703L100	23	100 mm DX20 - DX30	240,00
10703L200	23	200 mm DX20 - DX30	268,00

KIT PER RIVETTI STRUTTURALI

KIT FOR STRUCTURAL RIVETS



Morsetti / Jaws

Cod. / Code	Descrizione / description	€ / Cad.
10990	Morsetti per UNIBOLT Jaws for UNIBOLT	34,80 (3 pcs.)
10991	Cono per UNIBOLT Cone for UNIBOLT	25,00
10988	Ugello per UNIBOLT Ø 5 Nosepiece UNIBOLT Ø 5	19,20
10989	Ugello per UNIBOLT Ø 6,4 Nosepiece UNIBOLT Ø 6,4	19,20
10992	Ugello per MAGNA-LOCK Ø 5 Nosepiece MAGNA-LOCK Ø 5	14,00
10993	Ugello per MAGNA-LOCK Ø 6,4 Nosepiece MAGNA-LOCK Ø 6,4	14,00
109875	Ugello per TRIBOL 7,8 Nosepiece TRIBOL 7,8	9,00



Cono morsetti / Cone



Ugelli per UNIBOLT / Nosepiece



Ugelli per MAGNA LOCK / Nosepiece

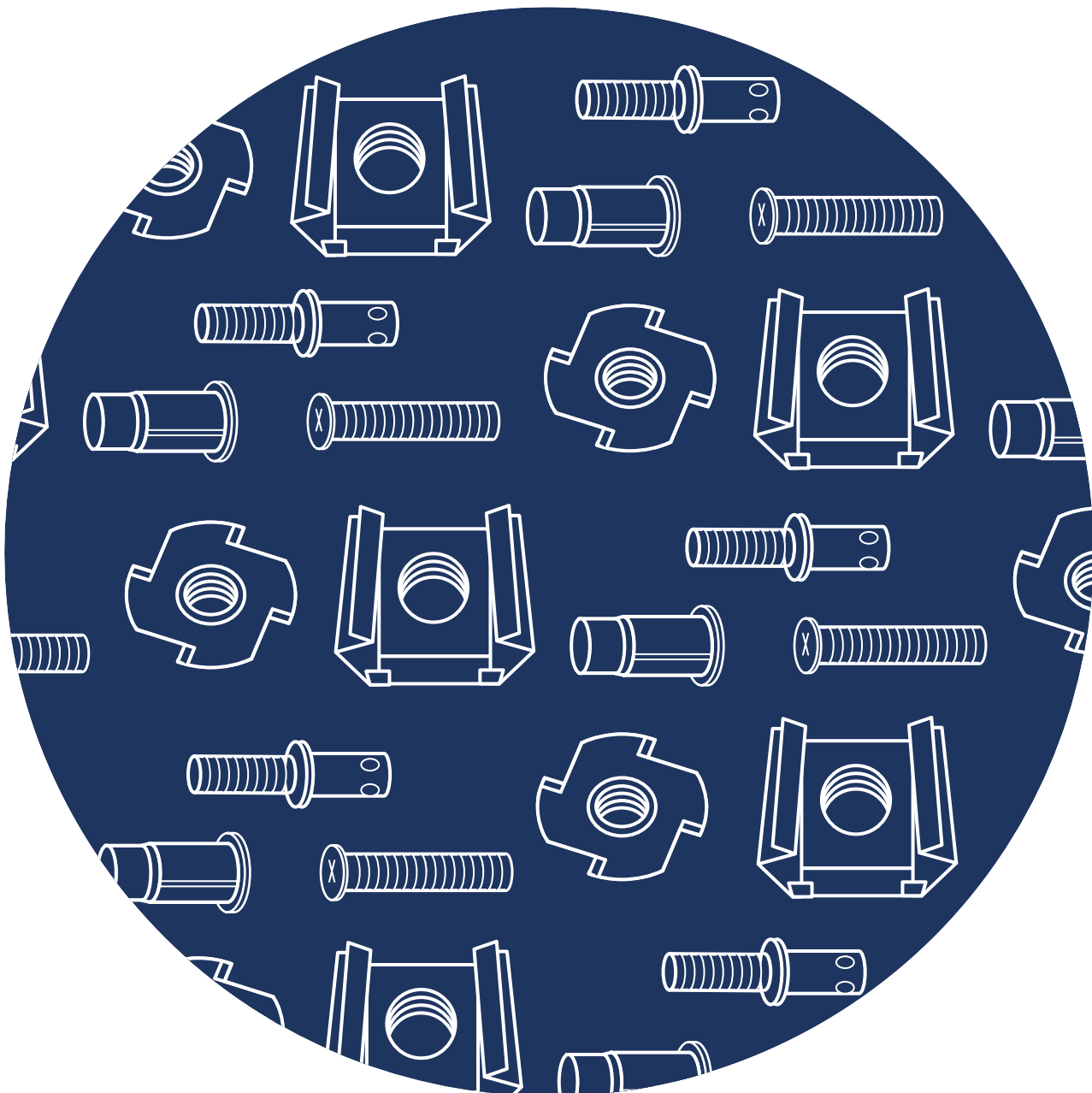

PRODOTTI SPECIALI
SPECIAL PRODUCTS
SPEZIELLE PRODUKTE

INSERTI FILETTATI MASCHIO IN ACCIAIO

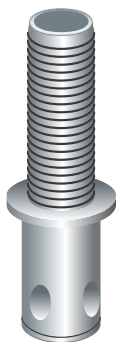

MALE THREADED STEEL INSERTS

MÄNNCHEN GEWINDE STAHL EINFÜGUNGEN

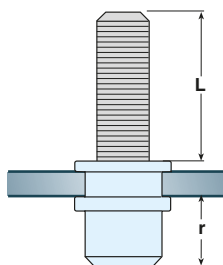
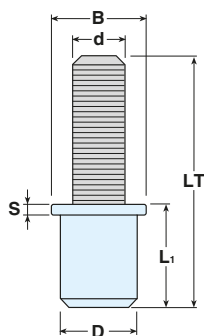

Acciaio Zincato
Zinc plated steel
Stahl Verzinkt



d 6H	D mm	B mm	S mm	 mm	 mm	r min÷max	L ₁ mm	L mm	LT mm	Cod. Art. Item code		€ per 1.000
M5	6,9	10	1	7	0,5÷3	6,0÷7,0	12	15 20 25	25 30 35	32M5 TPCMA 32M5 TPMMA 32M5 TPLMA	1.000	1.000
M6	8,9	13	1,5	9	0,5÷3	12,80	14,5	15 20 25	27 32 37	32M6 TPCMA 32M6 TPMMA 32M6 TPLMA	1.000	1.000
M8	10,9	16	1,5	11	0,5÷3	14,50	15,5	20 25	33 38	32M8 TPCMA 32M8 TPLMA	1.000	1.000

INSERTI FILETTATI A TESTA CILINDRICA IN ACCIAIO PER COMPOSITI

THREADED INSERTS CYLINDRICAL HEAD IN STEEL FOR COMPOSITES



BLIND-EINNIETMUTTERN-FLACHKOPF AUS STAHL-COMPOSITE

Acciaio Zincato
Zinc plated steel
Stahl Verzinkt

La particolare geometria di questo inserto consente di ottenere un'ampia controtesta, rendendolo adatto per l'applicazione su materiali plastici o composti.

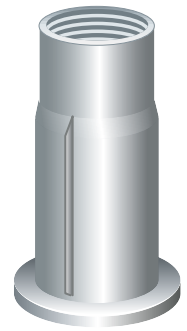
The particular geometry of this insert provides an extensive tailstock, making it suitable for application on plastic or compounds



d 6H	D mm	B mm	S mm	 mm	 mm	L ₁ mm	L mm	Cod. Art. Item code		€ per 1.000
M5	7	12,5	1,0	7,50	0,5÷4,50	9,90	22	32M5 IPP	3.000	
M6	9	15,5	1,60	8,90	0,5÷7,10	12,80	26	32M6 IPP	3.000	
M8	11	19,8	1,70	11,20	0,5÷7,10	14,50	29	32M8 IPP	3.000	

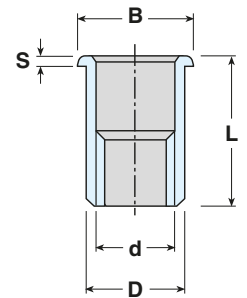

* Lotto minimo 30.000 pcs.

* Minimum quantity 30.000 pcs.



INSERTI FILETTATI A TESTA CILINDRICA JACKNUT

THREADED INSERTS CYLINDRICAL HEAD IN STEEL FOR PLASTIC

BLIND-EINNIETMUTTERN-FLACHKOPF AUS PLASTIK-STAHL

Acciaio Zincato
Zinc plated steel
Stahl Verzinkt



d 6H	D mm	B mm	S mm	 mm	 mm	L mm	Cod. Art. Item code		€ per 1.000
M4	8,1	11,9	1,8	8,2	0,4-4,7	16,6	32M4 JNC	5.000	
M5	9,7	13,5	1,8	9,8	0,4-4,7	18,2	32M5 JNC	3.000	
M6	11,2	15,9	1,8	11,3	0,4-4,7	18,6	32M6 JNC	3.000	

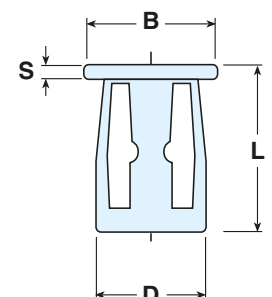

DADI IN GABBIA QUADRATA

CAGE NUTS

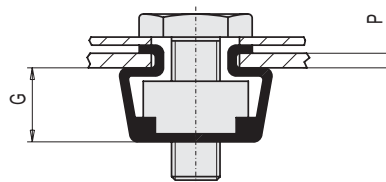
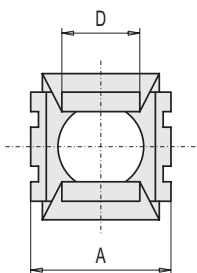
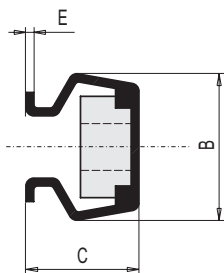

Materiale tutto acciaio zincato (disponibili anche in acciaio inox)

Ø vite	Dado	S= Spess. lamiera	Designazione	A +0,6-0	B ± 0,5	C ± 0,3	D ± 0,2	E	G ± 0,3	Foro lamiera	
M3	8x8x2,5	0,3-0,9	533 A	9,3	8,8	5,2	4,8	0,3	3,6		5.000
		1-1,6	533 B			5,9					
		1,7-2,3	533 C			6,6					
		2,4-3,1	533 D			7,4					
M4	8x8x2,5	0,3-0,9	534 A	9,3	8,8	5,2	4,8	0,3	3,6		5.000
		1-1,6	534 B			5,9					
		1,7-2,3	534 C			6,6					
		2,4-3,1	534 D			7,4					
M4	8x8x3,5	0,7-1,6	674 A	10	9	7,2	5,8	0,45	4,8		5.000
		1,7-2,6	674 B			8,2					
M5	8x8x3,5	0,7-1,6	675 A	10	9	7,2	5,8	0,45	4,8		5.000
		1,7-2,6	675 B			8,2					
M4	10x10x4	0,3-1,1	834 O	12	11,4	8	7,2	0,45	6		2.500
		1,2-1,6	834 A			8,5					
		1,7-2,5	834 B			9,5					
		2,6-3,5	834 C			10,5					
		3,6-4,5	834 D			11,5					
M5	10x10x4,5	0,3-1,1	835 O	12	11,4	8	7,2	0,45	6		2.500
		1,2-1,6	835 A			8,5					
		1,7-2,5	835 B			9,5					
		2,6-3,5	835 C			10,5					
		3,6-4,5	835 D			11,5					
M6	10x10x4,5	0,3-1,1	836 O	12	11,4	8	7,2	0,45	6		2.500
		1,2-1,6	836 A			8,5					
		1,7-2,5	836 B			9,5					
		2,6-3,5	836 C			10,5					
		3,6-4,5	836 D			11,5					
M4	11x11x4	0,7-1,6	954 A	13,8	13	8,5	8,2	0,45	6		2.500
		1,7-2,6	954 B			9,5					
		2,7-3,5	954 C			10,5					
M5	11x11x4,5	0,7-1,6	955 A	13,8	13	8,5	8,2	0,45	6		2.500
		1,7-2,6	955 B			9,5					
		2,7-3,5	955 C			10,5					
M6	11x11x4,5	0,7-1,6	956 A	13,8	13	8,5	8,2	0,45	6		2.500
		1,7-2,6	956 B			9,5					
		2,7-3,5	956 C			10,5					
M6	14x14x5	1-1,7	1236 A	16	15,5	10,4	10,6	0,5	7,8		1.500
		1,8-3,2	1236 B			12					
		3,3-4,7	1236 C			13,5					
M8	14x14x5,5	1-1,7	1238 A	16	15,5	10,4	10,6	0,5	7,8		1.500
		1,8-3,2	1238 B			12					
		3,3-4,7	1238 C			13,5					
M10	14x14x5,5	1-1,7	1231 A	16	15,5	10,4	10,6	0,5	7,8		1.500
		1,8-3,2	1231 B			12					
		3,3-4,7	1231 C			13,5					

DADI TONDI FILETTATI A 4 PUNTE PER LEGNO

ROUND THREADED NUTS 4 TIPS FOR WOOD

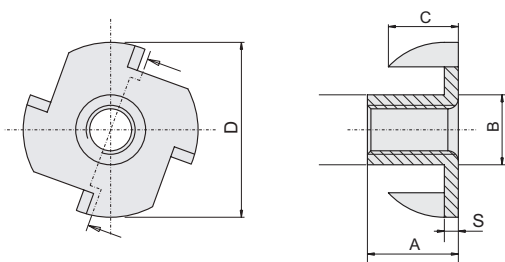

Materiale: acciaio zincato / acciaio grezzo

Questi dadi vengono inseriti a filo nel legno o in agglomerati grazie alle 4 punte, rappresentano il sistema ideale per fissare parti che possono essere sempre smontate.

These nuts are inserted in wood or wire in agglomerations with 4 bits, represent the ideal system for fixing parts which can be disassembled.

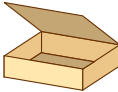
Ø vite	Codice	A	B	C	D	S	
M4	35 DA14PM400	7,5	5,5	5,0	17,00	1,0	5.000
M5	35 DA14PM501	6,0	6,0	5,0	17,00	1,0	5.000
	DA14PM502	7,0	6,5	5,0	17,00	1,0	5.000
	DA14PM503	8,0	6,5	5,0	17,00	1,0	5.000
	DA14PM504	10,0	6,5	5,0	17,00	1,0	5.000
M6	35 DA14PM601	9,0	8,2	7,5	19,00	1,2	5.000
	DA14PM603	12,0	8,2	7,5	19,00	1,2	5.000
M8	35 DA14PM801	11,0	10,8	8,0	22,00	1,5	3.000
M10	35 DA14PM101	12,0	11,5	9,5	25,00	1,5	3.000

MOLLETTE CON COLLARINO SERIE BUT 200

DEEP THREADED U NUTS BUT 200 SERIES

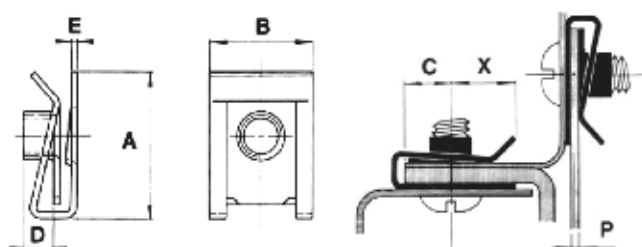

MATERIALI:
ACC C67 EN 10132-4
TRATTAMENTO SU RICHIESTA

MATERIALS:
CARBON STEEL C67S UNI EN
10132-4
TREATMENT: ZINC PLATED CHR. 3
TREATMENT ON REQUEST

Ø vite	P Spessore lamiera	Codice	A	B	C	X	D	E
M4	0,5-3	BUT 314 A	15,3	10	7,2	5,8	5	0,6
	2,0-4,0	BUT 314 B	15,3		7,2	5,8	5	0,6
	0,5-4	BUT 314 C	15		7,3	5	5	0,6
M5	0,5-4	BUT 315 C	20,5	14	11	10,5	5	0,6
	0,5-4	BUT 315 P	20,5	14	11	8,8	3,7	0,7
	0,5-4	BUT 415	15	12	7,3	7	3,7	0,6
M6	0,5-4	BUT 316 C	23,6	16	12	9,8	7	0,8
	0,5-4	BUT 316 P	23	15	12	9,8	5,5	0,8
	0,5-4	BUT 416	18	16	8,7	8,2	7	0,8
M8	0,5-4	BUT 318	24,3	17	13	10,8	8,3	1

MOLLETTE CON COLLARINO

DEEP THREADED U NUTS

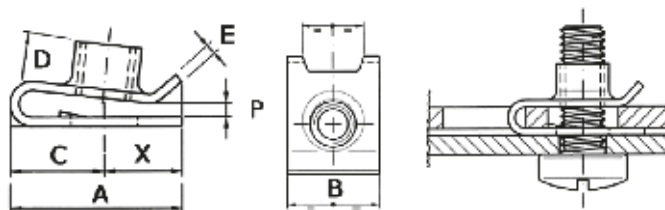

MATERIALI:
ACC C50 EN 10132-3
TRATTAMENTO SUPERFICIALE
SU RICHIESTA

MATERIALS:
STEEL C50 EN 10132-3
TREATMENT ON REQUEST

Ø vite	P Spessore lamiera	Codice	A	B	C	X	D ±0,3	E
M4	0,5-1,5	BUT-204A	15,5	12	8	6,5	3,5	0,8
	1,6-2,0	BUT-204B						
M5	0,5-1,5	BUT-205A	15,5	12	8	6,5	3,5	0,8
	1,6-2,0	BUT-205B						
M6	0,5-1,5	BUT-206A	15,5	12	8	6,5	5,8	0,8
	1,6-2,0	BUT-206B						

PIASTRINE DOPPIE PER VITI PARKER AUTOFILETTANTI

U NUTS FOR METRIC SCREWS

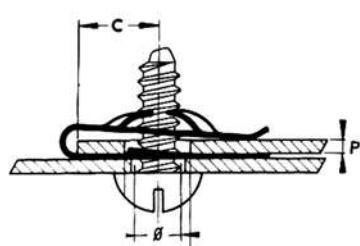
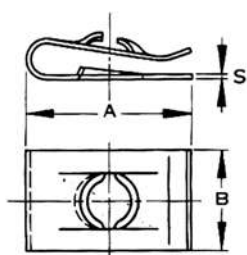

MATERIALI:
ACC C 67S EN 10132-4
TRATTAMENTO SU RICHIESTA

MATERIALS:
SPRING STEEL C67S EN 10132-4
TREATMENT ON REQUEST



Ø vite	P Spessore lamiera	Codice	A ± 0,3	B ± 0,3	C ± 0,03	S	Forma
M3	0,8-1,6	U3-503	12	8	6	0,3	C
M4	0,3-1,5	U4-315	16	12	8,5	0,4	A
	0,6-2,5	U4-601	16	10	7		C
	1-2,0	U4-501	18	10	8,5		C
	3,0-4,0	U4-520	17,5	10	7		C
M5	0,6-1,1	U5-2212-1	15	12	6,5	0,5	N
	0,6-1,4	U5-521-1	21		9,5	0,5	B
	1,2-1,8	U5-2212-2	15		6,5	0,5	N
	1,5-2,6	U5-212-2	21		9	0,5	B
	1,5-2,6	U5-509-2	24		12	0,5	B
	1,9-2,2	U5-2212-3	15		6	0,5	N
	1,0-3,0	U5-253	16,5		6	0,4	N
	2,3-3	U5-2212-4	15		5,5	0,5	G
M6	0,3-1,5	U6-2219-1	16,5	16	7,5	0,5	A
	1-1,8	U6-2219-2	16,5	16	8	0,5	A
	1,5-2,5	U6-517	25,5	14	11,5	0,5	C
	1,9-3	U6-2219-3	16,2	16	7,4	0,5	A
	2-3,2	U6-506	24,5	16	10	0,5	C
	3,3-4,6	U6-516	24,5	16	9	0,5	C
	5,5	U6-518	27	16	13	0,6	C

FORME - FORMS

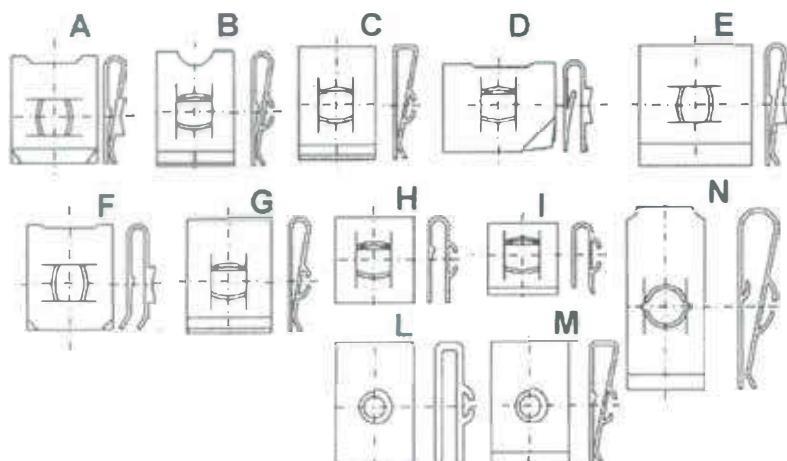
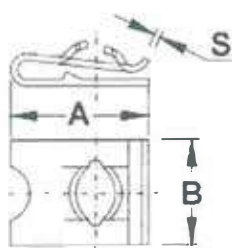

PERNI AUTOAGGANCIANTI

CLINCH STUDS

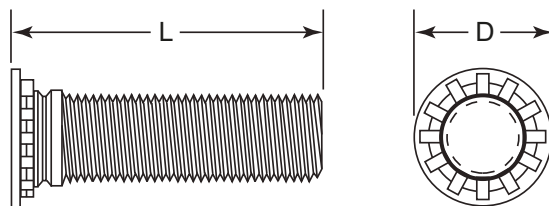

I PERNI della serie SFH sono costruiti per realizzare un filetto maschio su lamiere sottili. La testa del prigioniero affoga completamente nella lamiera dove rimane perfettamente a filo mentre la parte filettata resta perfettamente perpendicolare alla stessa.

SFH series pins are constructed to create a male thread on thin sheets. The prisoner's head completely in the sheet where drowning remains perfectly flush while the filleted part remains perfectly perpendicular to itself.

Serie	Materiale	Finitura	Utilizzo
SFHA	Acciaio al carbonio trattato termicamente	Zincatura bianca	Per Materiali con durezza HRB-80 o inferiori
SFHS	Acciaio Inox serie 300	Passivato	Per Materiali con durezza HRB-70 o inferiori

Come ordinare: serie + misura filetto + lunghezza **Es. 35 SFHA + M3 + 14**

Articolo	Misura filetto	Lunghezza $\pm 0,15$	Spessore minimo lamiera	Foro +0.08 0	D	Distanza minima bordo	Montaggio kN	Torsione N-m	Espulsione N	
35 SFHA-M03 35 SFHS-M03	M 3x0,5	6-8-10-12-15-18-20-22-25-28-30	1	3,0	4,6	5,6	15,5	1,2	1250	1.000
35 SFHA-M04 35 SFHS-M04	M 4x0,7	6-8-10-12-15-18-20-22-25-28-30-35-38	1	4,0	5,9	7,2	28,5	5,1	1780	1.000
35 SFHA-M05 35 SFHS-M05	M 5x0,8	8-10-12-15-18-20-22-25-28-30	1	5,0	6,5	7,2	30,0	6,5	2210	1.000
35 SFHA-M06 35 SFHS-M06	M 6x1,0	8-10-12-15-18-20-22-25-28-30	1,6	6,0	8,2	7,9	43,0	13,8	2610	1.000
35 SFHA-M08 35 SFHS-M08	M 8x1,25	10-12-15-18-20-22-25-28-30-35-38	2,4	8,0	9,6	9,6	45,0	22,2	3820	1.000

PERNI FILETTATI A SCARICA DI CONDENSATORE

THREADED PINS CAPACITOR DISCHARGE

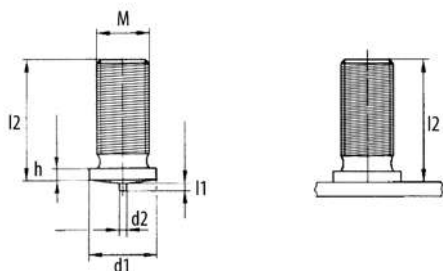

Il sistema a scarica di condensatori si utilizza su lamiere sottili, con spessore minimo di 0.5 mm e offre il particolare vantaggio di mantenere inalterato l'aspetto estetico del prodotto. La penetrazione della saldatura è di appena 0.1mm e ciò permette di non lasciare alcun segno di deformazione termica o meccanica sulla superficie a vista dell'oggetto saldato.

The capacitor discharge system you use on thin sheets, with minimum thickness of 0.5 mm and offers the particular advantage of keeping intact the aesthetic appearance of the product. Weld penetration is just 0.1 mm and this allows not to leave any sign of thermal or mechanical deformation on surface to the object's view.

Serie	Materiale
SPFSA	Acciaio ramato
SPFSI	Acciaio inox

Come ordinare: serie + misura filetto + lunghezza **Es. 35 SPFSA + M3 + 15**

Articolo	Ø vite	d1 ±0,1	d2 ±0,08	l1 ±0,55	h	Lunghezza ±0,55	
35 SPFSA-M3 35 SPFSI-M3	M3	4,5	0,60	0,55	0,7-1,4	6-8-10-12-15-20-25-30	1.000
35 SPFSA-M4 35 SPFSI-M4	M4	5,5	0,65	0,55	0,7-1,4	6-8-10-12-15-20-25-30	1.000
35 SPFSA-M5 35 SPFSI-M5	M5	6,5	0,75	0,80	0,7-1,4	6-8-10-12-15-20-25-30-35	1.000
35 SPFSA-M6 35 SPFSI-M6	M6	7,5	0,75	0,80	0,7-1,4	6-8-10-12-15-20-25-30-35-40	1.000
35 SPFSA-M8 35 SPFSI-M8	M8	9,0	0,80	0,90	0,7-1,4	6-8-10-12-15-20-25-30-35-40-45	1.000

CONDIZIONI GENERALI DI VENDITA

SACTO srl - CONDIZIONI GENERALI DI VENDITA

Le presenti Condizioni di Vendita si applicano a tutti gli ordini pervenuti a Sacto srl, ad eccezione degli ordini ricevuti via web / on line, da parte del Committente e annullano e sostituiscono qualsiasi altra condizione eventualmente apposta sugli ordini del Committente, salvo accordi particolari tra le Parti.

1-ORDINI E CONFERME D'ORDINE

Dopo aver effettuato ogni singolo ordine, il Committente riceverà da Sacto srl un modulo di conferma d'ordine entro i successivi 3 giorni lavorativi. Il predetto modulo dovrà essere debitamente timbrato e sottoscritto dal Committente e restituito a Sacto srl.

In caso di mancata restituzione o contestazione della conferma d'ordine da parte del Committente entro 2 giorni lavorativi successivi alla ricezione del modulo, la conferma d'ordine si riterrà accettata in ogni sua parte.

Sacto srl si riserva la facoltà di variare le quantità fornite per eccesso o per difetto per adattarle al proprio imballo standard.

Inoltre, in caso di fornitura di articoli speciali e a disegno, Sacto srl si riserva il diritto di applicare una tolleranza del $\pm 10\%$ sulla quantità in ordine.

Sacto garantisce un PPM standard di 800 pezzi. Qualsiasi altri valore richiesto, sarà quotato separatamente.

Qualora il Committente avesse la necessità di modificare o annullare un ordine in corso, dovrà inviare richiesta scritta a Sacto srl, che si riserverà la facoltà di accettare o rifiutare tale richiesta. In ogni caso, per articoli speciali e a disegno, in caso la produzione sia già stata avviata, non sarà possibile effettuare modifiche salvo espressa autorizzazione di Sacto srl. In caso il Committente volesse comunque annullare o modificare l'ordine, Sacto srl si riserverà il diritto di addebitare le spese sostenute a titolo di rimborso, nonché di trattenere eventuali acconti già versati dal cliente.

Si precisa infine che il minimo fatturabile per singolo ordine è di Euro 100,00 IVA esclusa.

2-PREZZI

I prezzi indicati all'interno del catalogo di Sacto srl e della conferma d'ordine sono da intendersi franco magazzino Sacto, IVA esclusa, ed esclusi trasporto, assicurazioni, tasse ed oneri doganali, salvo quanto diversamente pattuito nella conferma d'ordine. Per ordini con termini a scadenza, le quotazioni saranno quelle vigenti al momento della spedizione.

I prezzi si intendono comprensivi di imballo standard.

3-PAGAMENTI E RISERVA DI PROPRIETA'

I pagamenti, così come concordati tra le Parti, dovranno essere eseguiti presso il domicilio di Sacto srl. Non saranno ritenuti validi pagamenti con modalità diverse da quanto concordato, se non preventivamente autorizzati da Sacto srl. I pagamenti a mezzo tratta o ricevuta bancaria (RI.BA.) non derogano a quanto previsto dall'art. 1182 del C.C.

Qualunque ritardo nei pagamenti comporterà l'addebito degli interessi previsti in materia di transazioni commerciali dal D.Lgs. 08/10/2002 n° 231, oltre alle eventuali spese accessorie.

Ai sensi dell'art. 1461 C.C., è inoltre facoltà di Sacto srl sospendere l'adempimento delle obbligazioni derivanti dalla vendita nel caso in cui le condizioni patrimoniali del Committente divenissero tali da porre in serio pericolo il conseguimento della controprestazione.

In caso di compravendita con pagamenti rateizzati, la vendita sarà effettuata con la riserva della proprietà a favore di Sacto srl, in conformità al disposto dell'art 1523 c.c. e, conseguentemente, il Committente acquisterà la proprietà dei beni oggetto di ordine solo ed esclusivamente con il pagamento dell'ultima rata prevista.

4-SPEDIZIONI, TRASPORTO E CONSEGNA

Gli ordini verranno evasi a saldo nel limite delle disponibilità di Sacto srl, salvo specifica indicazione del Committente per mantenere in nota le eventuali rimanenze.

Salvo patto contrario, le modalità ed i mezzi di spedizione richiamano per intero la regola Incoterms 2024 EWW (Ex Works), salvo quanto previsto al successivo art. 5.

Conseguentemente, ogni servizio di trasporto e/o spedizione dovrà intendersi quale ulteriore ed accessorio rispetto all'ordine principale.

Il trasporto verrà effettuato con corriere nominato da Sacto srl con relativo addebito dei costi di trasporto, salvo diverse disposizioni.

La merce viaggia a rischio e pericolo del Committente dal momento della messa a disposizione della stessa in favore del vettore. In caso di danni, furti o ammanchi della merce durante il trasporto i relativi reclami dovranno essere indirizzati esclusivamente al vettore ricadendo su quest'ultimo la responsabilità.

Al momento della consegna, il Committente è tenuto a verificare che i dati riportati sul documento di trasporto corrispondano alla spedizione ricevuta; in presenza di discordanze è necessario farne esplicita riserva al vettore.

Se all'apertura dei colli integri dovesse risultare mancante parte della merce indicata nel documento di trasporto, ovvero se la stessa dovesse risultare difforme dalla merce indicata nella conferma d'ordine e specificato nel documento di trasporto, la relativa segnalazione dovrà essere inoltrata a Sacto srl, in forma scritta, entro e non oltre otto giorni dal ricevimento della merce (art. 1495 e 1511 c.c.), eventuali reclami successivi non potranno essere presi in considerazione né trovare accoglimento.

Qualsiasi ordine per il quale non sia stata sollevata alcuna contestazione conformemente a quanto sopra indicato viene considerato integralmente approvato e accettato dal Committente.

5-TERMINI DI CONSEGNA

Fatto salvo quanto specificamente concordato tra le Parti, Sacto srl non potrà essere ritenuta responsabile per ritardi di consegna e per perdite subite dal Committente a causa di tali ritardi.

Il termine di consegna indicato sul modulo di conferma d'ordine è parametrato ai programmi di approvvigionamento e realizzazione previsti al momento della ricezione dell'ordine e deve intendersi quale data di spedizione del materiale.

Tali termini sono indicativi, non essenziali ai sensi dell'art. 1457 C.C. e l'eventuale mancato rispetto degli stessi non darà diritto al Committente di richiedere alcun rimborso o risarcimento per ritardata consegna.

Sacto srl si riserva inoltre il diritto di effettuare consegne parziali a seconda della necessità e natura dell'ordine.

Qualsiasi variazione dei termini di consegna derivanti da forza maggiore o da altri eventi imprevedibili non imputabili a Sacto srl, ivi inclusi, senza alcuna limitazione, scioperi, serrate, disposizioni della pubblica amministrazione, successivi blocchi delle possibilità di esportazione o importazione, in considerazione della loro durata e della loro portata, libereranno Sacto srl dall'obbligo di rispettare qualsiasi termine di consegna eventualmente concordato.

Se il carico o il trasporto della merce è ritardato per motivi dipendenti dal committente, Sacto srl dovrà ritenersi autorizzata a conservare la merce a sua discrezione, riservandosi il diritto di addebito delle spese di stoccaggio. Tale clausola sarà da ritenersi applicabile anche per le merci che sono state segnalate come pronte per la spedizione e la cui consegna non è reclamata dal Committente entro cinque giorni.

Il Committente sarà tenuto, previa richiesta da parte di Sacto srl, a fornire adeguata giustificazione sul ritardato adempimento delle proprie prestazioni.

6-RESI DI MATERIALE

Qualsiasi reso di merce per cause non imputabili a Sacto srl o per errori di ordinazione sarà accettato solo se preventivamente autorizzato. Inoltre, Sacto avrà la facoltà di richiedere al Committente un rimborso pari alle spese sostenute da Sacto a titolo amministrativo, logistico e di ricondizionamento. In ogni caso, il reso verrà accettato solo se inviato in porto franco ed accompagnato da regolare documento di trasporto e soltanto nel caso in cui la merce non risulti danneggiata e/o manomessa.

7-GARANZIA

I prodotti che verranno riconosciuti difettosi da parte di Sacto srl, entro il termine di mesi 12 dalla ricezione della merce, saranno sostituiti o riparati in garanzia.

La garanzia legale e contrattuale è operante esclusivamente in presenza di difetti dipendenti da vizi di costruzione chiaramente imputabili a Sacto srl.

Sacto srl non garantisce per i difetti dovuti a (i) danni causati durante il trasporto; (ii) uso negligente o improprio del prodotto; (iii) inosservanza delle istruzioni di Sacto S.r.l. relative al funzionamento, manutenzione e conservazione del bene; (iv) riparazioni o modifiche apportate dal Committente o da soggetti terzi senza l'autorizzazione di Sacto srl.

In ogni caso, non verranno sostituiti prodotti danneggiati a causa di usura rientrante nella norma.

8-CARATTERISTICHE DEI PRODOTTI CONTENUTI NEL CATALOGO

Tutti i dati e le caratteristiche tecniche dei prodotti riportati nel catalogo Sacto srl sono indicativi e non vincolanti. Eventuali modifiche, per qualsiasi motivo, potranno essere apportate senza obbligo di preavviso al Committente e non potranno giustificare reclami da parte di quest'ultimo.

9-DIRITTI DI BREVETTO E PROPRIETA' INTELLETTUALE - MANLEVA

Il Committente riconosce che tutti i Diritti di Privativa Industriale e Intellettuale e di utilizzazione economica dei prodotti all'interno del catalogo Sacto srl (anche ai sensi della legge 633/41 e/o di ogni vigente disposizione di legge) sono e rimarranno di esclusiva proprietà di quest'ultima. Altresì, resterà in capo a Sacto srl qualsivoglia diritto relativo ai concetti, le idee, il know-how, le competenze e le metodologie di lavoro che dovessero emergere o essere elaborate nel corso dell'esecuzione dell'ordine e ciò anche qualora le stesse dovessero concretizzarsi in invenzioni, scoperte o miglioramenti, con la conseguenza che eventuali diritti di brevetto rimarranno comunque in capo a Sacto srl.

Se il committente richiedesse a Sacto srl di utilizzare per la fornitura di tutto o di parte dei prodotti e/o servizi ordinati, un modello, tecnica, un qualsiasi tipo di procedura, software e/o più generalmente qualsiasi creazione, al quale i diritti di proprietà intellettuale vengano forniti dal Committente, quest'ultimo garantisce di essere in possesso di tutti i diritti di proprietà intellettuale per il quieto uso da parte di Sacto srl. Quindi, il committente si impegna a manlevare e tenere indenne Sacto srl da e contro qualsiasi responsabilità, danno, perdita, costo o spesa derivante da o in qualsiasi modo connesso a richieste, azioni o reclami di terze parti relativi alla violazione di Diritti di Privativa Industriale e Intellettuale e di utilizzazione economica, segreti commerciali o altri diritti di proprietà intellettuale, legati ai prodotti e/o servizi ordinati.

Il Committente si impegna altresì a fornire tempestivamente tutte le informazioni e i documenti necessari a Sacto srl per difendersi da tali richieste, azioni o reclami, nonché a cooperare pienamente con Sacto srl nella gestione di tali difese.

La presente clausola di manleva rimarrà in vigore anche dopo la cessazione del contratto per qualsiasi motivo, in relazione a fatti o circostanze connesse alla fornitura.

10 - CONTROVERSIE

Le presenti Condizioni di Vendita ed ogni singola Vendita sono regolate e interpretate in conformità alla Legge Italiana che varrà per tutto quanto non espressamente sopra contemplato. Qualsiasi controversia, che non possa essere composta in sede stragiudiziale, relativa all'interpretazione ed esecuzione delle presenti Condizioni Contrattuali verrà devoluta all'esclusiva competenza del Foro di Monza.

11 - DISPOSIZIONI GENERALI

Le presenti Condizioni Generali di Vendita annullano e sostituiscono tutte quelle precedentemente pubblicate.

SACTO s.r.l.

GENERAL SALE CONDITIONS

SACTO srl - GENERAL SALE CONDITIONS

The present sale conditions apply to all orders submitted to Sacto srl from the Customer and they invalidate and replace any other conditions that may be placed on the Customer's orders, except for special agreements between the Parties.

1- ORDERS AND ORDER CONFIRMATIONS

After placing each individual order, the Customer will receive an order confirmation form from Sacto srl within the following 3 working days. The aforementioned form must be duly stamped and signed by the Client and returned to Sacto srl.

In the situation when, within 2 working days from the receipt of the form, we haven't received it back, we will consider you have totally accepted the order confirmation.

Sacto srl reserves the right to modify the quantities supplied by excess or deficiency, to adapt them to its standard packaging.

Furthermore, in the case of supply of special and custom-made items, Sacto srl reserves the right to apply a tolerance of $\pm 10\%$ on the quantity ordered.

Sacto guarantees a standard PPM of 800 pieces. Any other values required will be quoted separately.

If the Customer needs to modify or cancel an order in progress, he must send a written request to Sacto srl, which reserves the right to accept or refuse such request. In any case, for special and custom-made items, if production has already started, it will not be possible to make changes unless expressly authorized by Sacto srl. If the Customer nevertheless wishes to cancel or modify the order, Sacto srl reserves the right to charge the expenses incurred by way of reimbursement, as well as to withhold any advance payments already paid by the customer.

Finally, it should be noted that the minimum billable amount per single order is Euro 100.00 excluding VAT.

2- PRICES

The prices indicated in the Sacto srl catalog and in the order confirmation are to be understood ex Sacto warehouse, excluding VAT, and excluding transport, insurance, taxes and customs charges, unless otherwise agreed in the order confirmation. For program orders, the prices will be those valid at the time of shipment. Prices include standard packaging.

3- PAYMENTS AND RETENTION OF OWNERSHIP

Payments, as agreed between the Parties, must be made at the headquarters of Sacto srl. Payments made by means different from those settled between the parties will not be considered as valid, unless they had been previously authorized by Sacto srl. Payments by draft or checks do not derogate from the provisions of the art. 1182 of the civil code

Any delay in payment will generate the collection of interest, according to regulations of commercial transactions by D.Lgs. 10.08.2002 n. 231, in addition to any additional costs.

In compliance with art. 1461 of Italian C.C., Sacto srl also has the right to suspend the execution of the obligations arising from the sale in case the economic conditions of the Customer might jeopardize the performance, except of the performance of a conformable warranty.

In case of sale with payment in installments, the sale will be carried out with retention of title in favor of Sacto srl, in accordance with the provisions of art. 1523 of the civil code and, consequently, the Customer will acquire ownership of the goods covered by the order only upon payment of the last due date.

4- SHIPMENTS, TRANSPORT AND DELIVERY

Orders will be carried out within the limits of Sacto srl's availability, unless specifically indicated by the Client to keep on order the potential inventories. Unless otherwise agreed, the shipping methods fully refer to the Incoterms 2024 EWK (Ex Works) rule, except as provided in the following art. 5. Consequently, each transport and/or shipping service must be understood as additional and accessory to the main order. Transport will be carried out by courier appointed by Sacto srl with relative transport costs charged, unless otherwise specified. The goods travel at the risk of the Customer from the moment they are made available to the carrier. In the event of damage, theft or shortages of the goods during transport, the relevant complaints must be addressed exclusively to the carrier, since the responsibility falling on the latter.

At the time of delivery, the Customer is required to verify that the data reported on the transport document correspond to the goods received; in the presence of discrepancies, it is necessary to make an explicit reservation to the carrier. If, upon opening the intact packages, part of the goods indicated in the transport document is missing, or if the same is found to differ from the goods indicated in the order confirmation and specified in the transport document, the relevant notification must be forwarded to Sacto srl, in writing, no later than eight days from receipt of the goods (articles 1495 and 1511 of the Civil Code); any subsequent complaints cannot be taken into consideration or accepted. Any order for which no dispute has been raised in accordance with the above is considered fully approved and accepted by the Client.

5- DELIVERY TERMS

Except as specifically agreed between the Parties, Sacto srl is not responsible for delivery delays and for losses suffered by the Client due to such delays.

The delivery term indicated on the order confirmation may vary, depending on the supply schedules provisioned at the time of the order's reception and it must be understood at shipment term.

These terms have an indicative character and not a binding one, complying with art. 1457 Civil Code, and failure to comply with this term will not give the Customer the right to request any refund or compensation for delay delivery. Sacto srl also reserves the right to make partial deliveries depending on the need and nature of the order.

Any variation in delivery terms resulting from force majeure or other unforeseeable events not attributable to Sacto srl, including, without any limitation, strikes, lockouts, provisions of the public administration, subsequent blocking of export or import possibilities, in consideration of their duration and scope, will free Sacto srl from the obligation to respect any delivery deadline agreed.

If the loading or transport of the goods is delayed for reasons dependent on the customer, Sacto srl must be considered authorized to store the goods at its discretion, reserving the right to charge storage costs. This clause will also be considered applicable for goods that have been reported as ready for shipment and whose delivery is not claimed by the Customer within five days.

The Customer will be required, upon request by Sacto srl, to provide adequate justification for the delayed fulfillment of its services.

6- RETURNS OF GOODS

Any return of goods for reasons not attributable to Sacto srl or for ordering errors will be accepted only if authorized in advance from Sacto itself. Furthermore, Sacto will have the right to request to the Customer a reimbursement equal to the expenses incurred by Sacto for administrative, logistical and reconditioning purposes. In any case, the return will be accepted only if sent carriage paid and accompanied by a regular transport document and only if the goods are not damaged and/or tampered with.

7- WARRANTY

Sacto warranty of product defects is valid for 12 months from the receipt of the goods

The legal and contractual warranty is exclusively used in case of defects related to construction flaws.

Sacto srl does not provide a warranty for defects caused by (i) damaged occurred during transport; (ii) improper or careless use of the product; (iii) failure to observe the instructions of Sacto srl related to functioning, maintenance and preservation of the product; (iv) repairs or modifications carried out by the buyer or third parties, without any authorization of Sacto srl.

In any case, products damaged due normal use is not to be replaced.

8- CHARACTERISTICS OF CATALOGUE PRODUCTS

All technical data and characteristics of the products exhibited in Sacto srl's catalogue have an indicative character and not a binding one. Potential modifications, regardless the reason, are allowed to be made without notifying in advance the Customer and they will not justify potential claims of the beneficiary.

9- PATENT AND INTELLECTUAL PROPERTY RIGHTS - INDEMNIFICATION

The Customer acknowledges that all Industrial and Intellectual Proprietary Rights and Rights to the economic use of the products within the Sacto srl catalogue (also in accordance with Law 633/41 and/or any applicable law provisions) are and will remain the exclusive property of the latter. Furthermore, any right relating to concepts, ideas, know-how, skills and working methods which may emerge or be developed during the execution of the order will remain with Sacto srl, and this also in the event that the same should take the form of inventions, discoveries or improvements, with the consequence that any patent rights shall in any case remain with Sacto srl.

If the Customer requests Sacto srl to use, for the supply of all or part of the products and/or services ordered, a model, technique, any type of procedure, software and/or more generally any creation, to which intellectual property rights are provided by the Customer, the latter guarantees to be in possession of all intellectual property rights for the quiet use by Sacto srl.

Therefore, the Customer undertakes to indemnify and hold Sacto srl harmless from and against any liability, damage, loss, cost or expense arising out of or in any way connected requests, actions or complaints by third parties relating to the violation of Industrial and Intellectual Property Rights and economic use, trade secrets or other intellectual property rights, linked to the products and/or services ordered.

The Customer further agrees to promptly provide all information and documents necessary for Sacto srl to defend itself from such claims, actions or complaints, and to cooperate fully with Sacto srl in the management of such defences.

This indemnity clause shall remain in effect even after the termination of the contract for any reason in relation with any facts or circumstances related to the supply.

10- DISPUTES

These Terms and Conditions of Sale and each individual Sale are governed by and interpreted in accordance with Italian Law which will apply to everything not expressly contemplated above. Any dispute, which cannot be settled out of court, relating to the interpretation and execution of these Conditions of Sale will be referred to the exclusive jurisdiction of the Court of Monza.

11- GENERAL PROVISIONS

These General Terms and Conditions of Sale cancel and replace all those previously published.

SACTO s.r.l.

Stampato ad Aprile 2026 da Forma Printing S.r.l. - Grassobbio (BG)

È vietata ogni utilizzazione anche parziale e/o riproduzione anche parziale del testo, dei disegni e delle fotografie senza l'autorizzazione scritta della Sacto srl.



MADE IN ITALY • SINCE 1974



SACTO Srl

Via C. Porta, 61

20831 Seregno MB - ITALY

+39 0362 232307

info@sacto.it

WWW.SACTO.IT